

Mounting flange AQM63.0

QAM2110.040, QAM2120.040

QAM2120.200, QAM2120.600

Symaro™

Duct Temperature Sensors QAM21...

Passive sensors for acquiring the air temperature in air ducts.

Use

The duct temperature sensors are for use in ventilation and air conditioning plants as:

- Supply or extract air temperature sensors
- Limit sensors, e.g. for minimum limitation of the supply air temperature
- Reference sensors, e.g. for shifting the room temperature as a function of the outside temperature
- Measuring sensors, e.g. for measured value indication or for connection to a building automation and control system

Type summary

Type reference	Probe length	Mounting clamps	Sensing element
QAM2110.040	0,4 m	no	Pt 100
QAM2112.040	0,4 m	no	Pt 1000
QAM2112.200	2,0 m	4 pcs.	Pt 1000
QAM2120.040	0,4 m	no	LG-Ni 1000
QAM2120.200	2,0 m	4 pcs.	LG-Ni 1000
QAM2120.600	6,0 m	6 pcs	LG-Ni 1000
QAM2130.040	0,4 m	no	NTC 10k

Accessories
(Spare parts)

Name	Type reference
Capillary tube clamp for the QAM2120.200 and QAM2120.600 (6 pieces)	AQM63.3
Mounting flange	AQM63.0

Ordering and delivery

When ordering, please give name and type reference, e.g.:

Duct temperature sensor **QAM2120.040**

The sensor is supplied complete with mounting flange AQM63.0 and, if required, mounting clamps AQM63.3.

Equipment combinations

All systems or devices capable of acquiring and handling the sensor's passive output signal.

Function

The sensor acquires the air temperature via its sensing element whose resistance changes as a function of the temperature. The signal is delivered to a suitable controller for further handling.

Sensing elements

LG-Ni 1000

Characteristic:

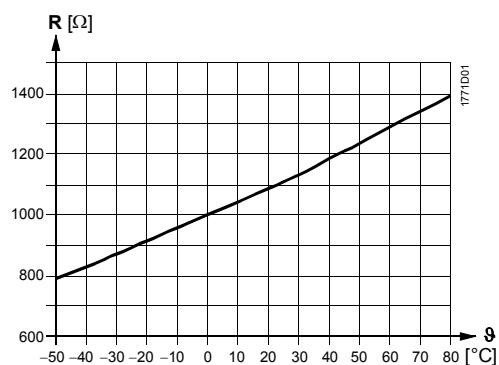

Accuracy:

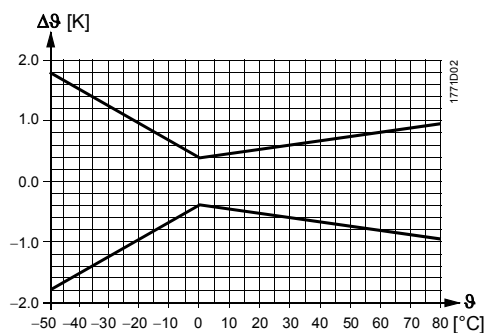

Pt 100 (class B)

Characteristic:

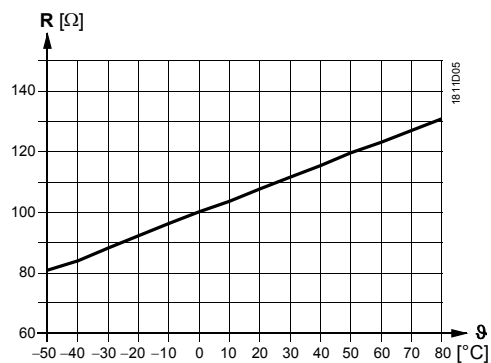

Accuracy:

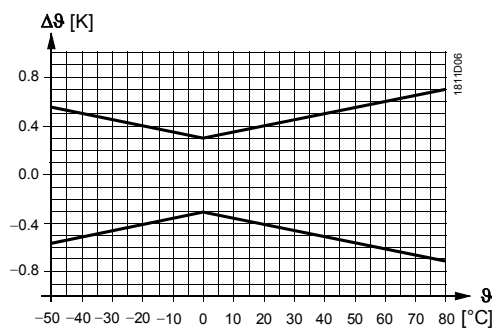

Pt 1000 (class B)

Characteristic:

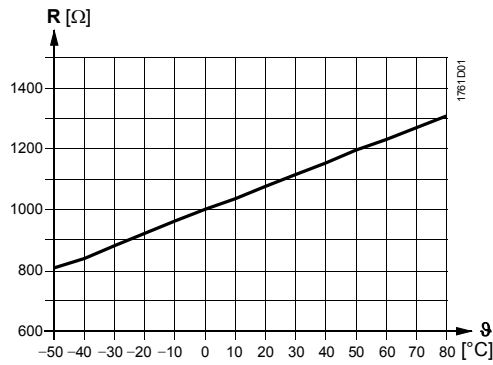

Accuracy:

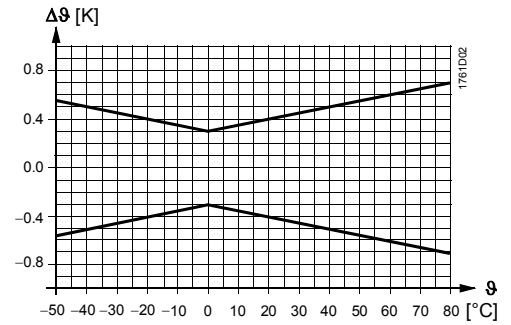

NTC 10k

Characteristic:

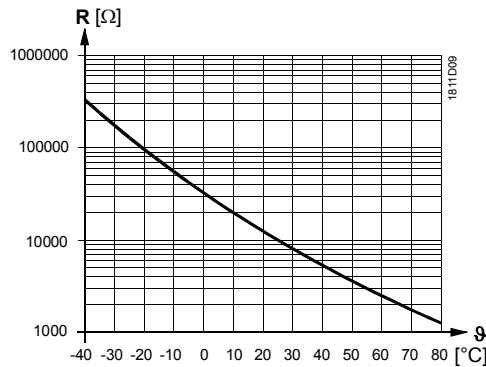

Accuracy:

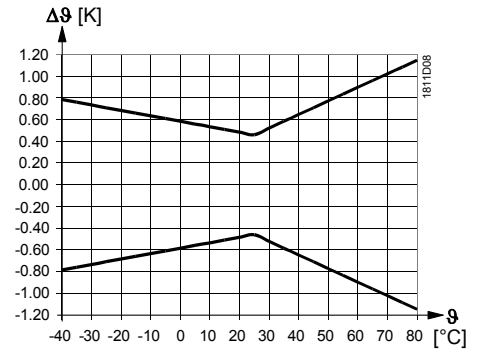

Legend

- R Resistance value in Ohm
- θ Temperature in degrees Celsius
- Δθ Temperature differential in Kelvin

Mechanical design

The duct temperature sensor consists of the following components:

- Two-sectional plastic housing comprised of base with connection terminals and removable cover (snap-on design)
- Fully active, flexible probe with sensing element which acquires the average temperature

The connection terminals can be accessed after removing the cover. Cable entry is made via a grommet which, if required, can be replaced by a cable entry gland M16 (IP 54).

After fitting the mounting flange, the sensor can be installed in 6 different immersion positions so that the sensor housing is always located outside the insulation for layers up to 70 mm. The probe with a length of 2 or 6 m is to be fitted across the air duct with the help of the mounting clamps supplied with the sensor.

Mounting notes

Mounting location

- *For supply air temperature control:* Downstream from the fan, if the fan is located after the last air handling unit. Otherwise, after the last air handling unit with a minimum distance of 0.5 m
- *For extract air temperature control:* Always upstream of the extract air fan
- *As a limit sensor for the supply air temperature:* As close as possible to the air outlet into the room
- *For dew point control:* Immediately after the spray trap of the air washer

Manually bend the probe so that it lies diagonally across the duct or in equally spaced windings across the entire duct cross-section. The probe must not touch the duct wall.

The sensor is supplied complete with Mounting Instructions.

Mounting positions

permitted:



not permitted:



Mounting examples

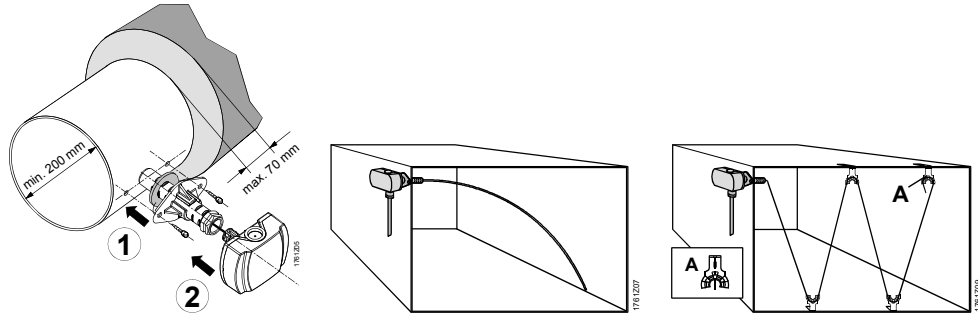

Technical data

Functional data	Operating range	-40...+80 °C for NTC type -50...+80 °C other types
	Sensing element	refer to "Type summary"
	Probe	
	Length	refer to "Type summary"
	Min. bending radius	10 mm
	Time constant	30 s at 2 m/s
	Dead time	< 1 s
Protective data	Measuring accuracy	refer to "Function"
	Protection standard of housing	IP 42 to IEC 60529
	With cable entry gland M 16 x 1.5	IP 54 to IEC 60529 (not included as standard)
Electrical connections	Safety class	III to EN 60730 (only with SELV or PELV)
	Screw terminals for	1 x 2.5 mm ² or 2 x 1.5 mm ²
	Cable entry	
Environmental conditions	Grommet	for 5.5...7.2 mm dia. cable
	Cable entry gland	M 16 x 1.5 can be fitted
	Perm. cable lengths	refer to Data Sheet of the relevant controller
	Operation	to IEC 60721-3-3
	Climatic conditions	class 3K5
	Temperature (housing)	-40...+70 °C
	Humidity (housing)	5...95 % r. h.
Transport	to IEC 60721-3-2	
Climatic conditions	class 2K3	
Temperature	-25...+70 °C	
Humidity	<95 % r. h.	
Mechanical conditions	class 2M2	

Materials and colors

Probe	copper, polyolefine
Base	polycarbonate, RAL 7001 (silver-grey)
Cover	polycarbonate, RAL 7035 (light-grey)
Mounting flange	PA 66 (black)
Clamps	PA-GF 35 (black)
Packaging	corrugated cardboard

Weight

Incl. packaging		
QAM2110.040		ca. 0,15 kg
QAM2112.040		ca. 0,15 kg
QAM2112.200		ca. 0,3 kg
QAM2120.040		ca. 0,15 kg
QAM2120.200		ca. 0,30 kg
QAM2120.600		ca. 0,53 kg
QAM2130.040		ca. 0,15 kg

Internal diagram

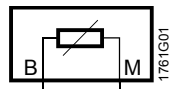

The internal diagram is identical for all types of duct temperature sensors covered by this Data Sheet.

The connecting wires are interchangeable.

Dimensions

