

**Magnet**

Type designation **T-62 N/S**

Item number **6301262039**

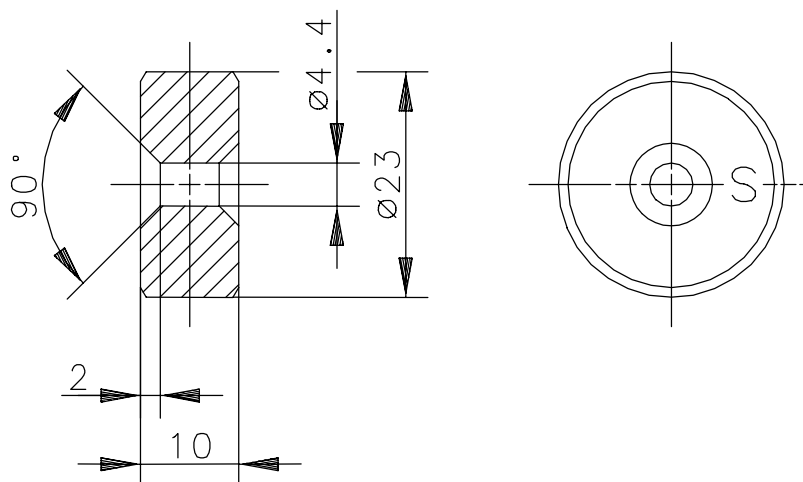

**Characteristic features**

**Mechanical data**

Magnet	Hartferrit 24/16; axial magnetisation; marking on the south pole side
Ambient air temperature	-40°C ... +150°C
Application	general use

This document will not become the contractual basis; the details included herein do not constitute any descriptions of expected conditions, so that warranties/claims for defects on account of possible variations of the actual from the here described condition are excluded. Subject to modifications and amendments.

Date of issue: 12.11.2004 / Page 1 of 1  
Document: 6301262039\_en / Last update: 1 / 0690-04