

Power PCB Relay RP II/2

2 pole 8 A



F0150-B

Features

- 2 C/O or 2 N/O contacts
- 4 kV / 8 mm coil-contact
- Twin contacts available
- Sockets with PCB-type or screw-type terminals

Applications

Domestic appliances, UPS's



Technical data of approved types on request

Contact data

Configuration	2 C/O contact or 2 N/O contact
Type of contact	single contact
Rated current	8 A (UL: 10 A)
Rated voltage / max.breaking voltage AC	250 Vac / 440 Vac
Maximum breaking capacity AC	2000 VA
Make current (max. 4 s at duty cycle 10%)	14 A
Contact material	Ag, AgCdO

Contact ratings

Type	Load	Operations	Standard
RP440	64 A ON, 2 A OFF, 250 Vac	1x10 ⁴	VDE 0860
RP421	2 A, 50 Vdc, resistive	approx. 2x10 ⁵	
RP421	1/10hp, 240 Vac, per contact		UL 508
RP421	3 A, 380 Vac, AC11	approx. 3x10 ⁴	VDE 0660
RP421	0.18 A, 110 Vdc, DC11	approx. 1x10 ⁵	VDE 0660
RP420	0.6 A, 220 Vac, cosφ=0.8, single phase motor	approx. 1.3x10 ⁶	

Coil data

Nominal voltage	5...110 Vdc
Nominal coil power	500 mW
Operate category	2 / b

Coil versions, DC-coil

Coil code	Nominal voltage Vdc	Pull-in voltage Vdc	Release voltage Vdc	Maximum voltage Vdc	Coil resistance Ω	Coil current mA
005	5	3.5	0.5	9.0	54±10%	92.6
006	6	4.2	0.6	10.8	68±10%	88.2
012	12	8.4	1.2	21.6	270±10%	44.4
024	24	16.8	2.4	43.2	1100±15%	21.8
048	48	33.6	4.8	86.4	4400±15%	10.9
060	60	42.0	6.0	108.0	6540±15%	9.2
110	110	77.0	11.0	198.0	23100±15%	4.8

All figures are given for coil without preenergization, at ambient temperature +20 °C
Other coil voltages on request

Max. DC load breaking capacity

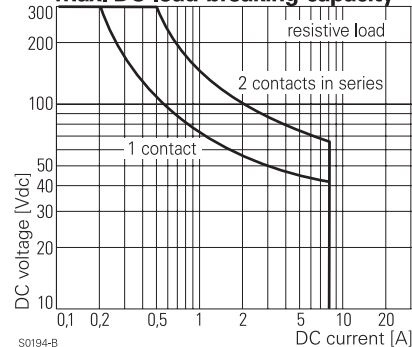

S0194-B

Electrical endurance

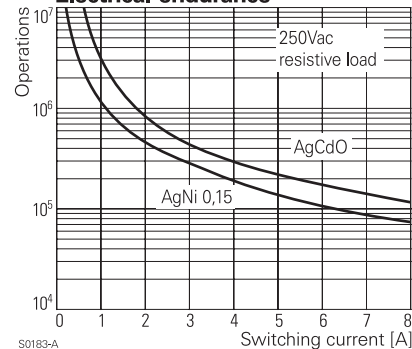

S0183-A

Coil operating range DC

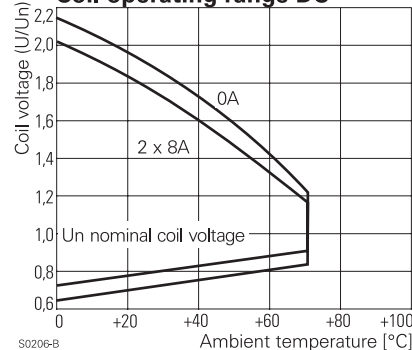

S0206-B

Power PCB Relay RP II/2

2 pole 8 A

Insulation

Dielectric strength	coil-contacts	4000 V _{rms}
	open contact circuit	1000 V _{rms}
	adjacent contacts	2500 V _{rms}
Clearance / creepage		8 / 8 mm
Insulation to IEC 60664		
Voltage rating		250
Pollution degree		3
Overvoltage category		III
Insulation to VDE 0110b (2/79)		
Insulation category / reference voltage		C / 250

Other data

Ambient temperature	-40...+70 °C	
Mechanical life	20x10 ⁶ operations	
Max. switching rate at rated- / minimum load	10 min ⁻¹ / 1200 min ⁻¹	
Operate- / release time	typ. 9 / 3 ms	
Bounce time N/O contact/N/C contact	typ. 2 / 3 ms	
Vibration resistance N/O / N/C contact	11 / 1.5 g, 30...150 Hz	
Shock resistance (destruction)	100 g	
Category of protection (IEC 61810)	RT II - flux proof, RT III - wash tight	
Relay weight	18 g	
Packaging unit	20 / 500 pcs.	
Accessories	see accessories RP	

PCB layout / terminal assignment

View on solder pins
Dimensions in mm

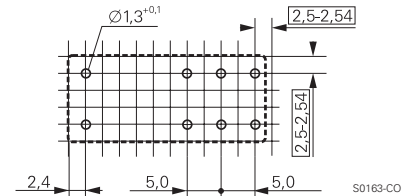

2 C/O contacts

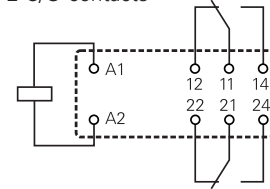

2 N/O contacts

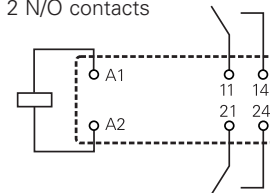

Dimensions

Dimensions in mm

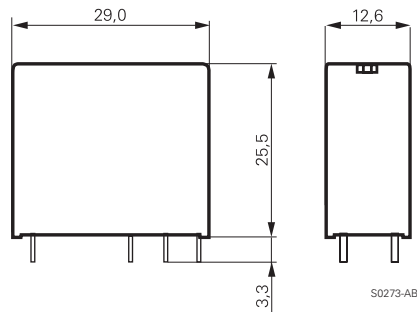

Product key

Type	R P					
Version	5	8A, flux proof	8	8A, wash tight		
Contact	2	2 C/O contacts	4	2 N/O contacts		
Contact material	0	AgCdO	1	Ag	C	Ag, twin contacts, gold plated
Coil	Coil code: please refer to coil versions table					

Preferred types in bold print

Rights to change data / design reserved