



Up to Category 4, EN 954-1 PNOZ XV2P



Safety relay for monitoring E-STOP pushbuttons and safety gates.

Approvals

	PNOZ XV2P
	◆
	◆
	◆

Unit features

- ▶ Positive-guided relay outputs:
 - 2 safety contacts (N/O), instantaneous
 - 2 safety contacts (N/O), delay-on de-energisation
- ▶ Connection options for:
 - E-STOP pushbutton
 - Safety gate limit switch
 - Reset button
- ▶ Delay-on de-energisation, fixed or selectable
- ▶ Delay time can be cancelled via reset button
- ▶ LED indicator for:
 - Switch status channel 1/2
 - Supply voltage
 - Reset circuit
- ▶ Plug-in connection terminals (either cage clamp terminal or screw terminal)
- ▶ See order reference for unit types

Unit description

The safety relay meets the requirements of EN 60204-1 and IEC 60204-1 and may be used in applications with

- ▶ E-STOP pushbuttons
- ▶ Safety gates

The max. category the safety contacts can achieve in accordance with EN 954-1 is stated in the technical details.

Safety features

The relay conforms to the following safety criteria:

- ▶ The circuit is redundant with built-in self-monitoring.
- ▶ The safety function remains effective in the case of a component failure.
- ▶ The correct opening and closing of the safety function relays is tested automatically in each on-off cycle.
- ▶ The unit has an electronic fuse.

Block diagram

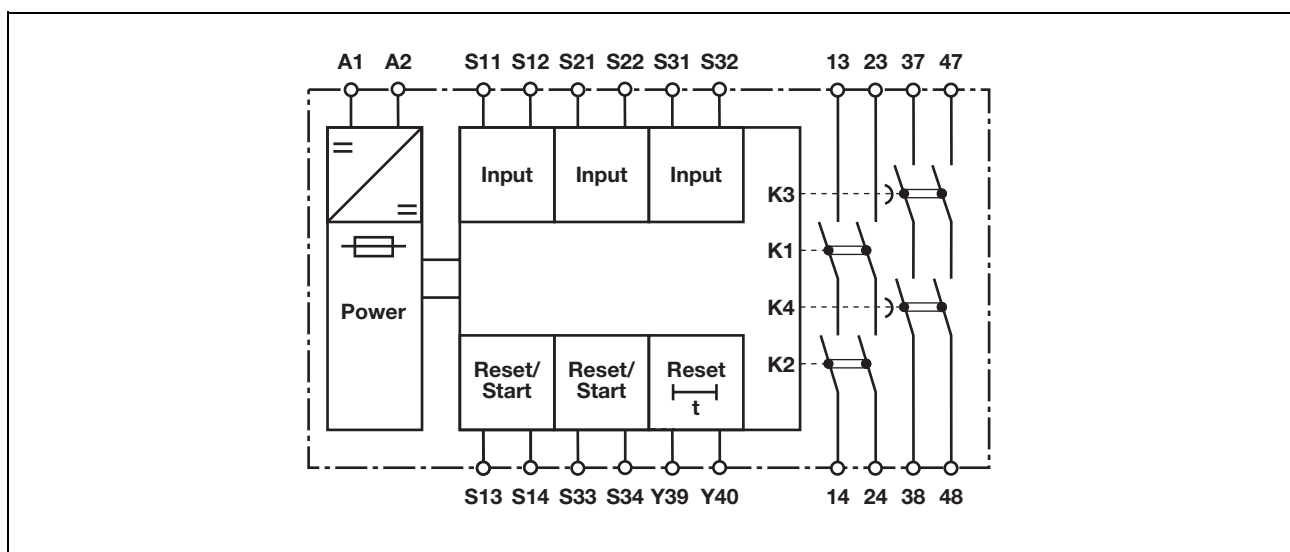

Up to Category 4, EN 954-1 PNOZ XV2P

Function description

- ▶ Single-channel operation: no redundancy in the input circuit, earth faults in the reset and input circuit are detected.
- ▶ Dual-channel operation with detection of shorts across contacts: redundant input circuit, detects
 - earth faults in the reset and input circuit,
 - short circuits in the input circuit and, with a monitored reset, in the reset circuit too,
 - shorts between contacts in the input circuit.
- ▶ Automatic start: Unit is active once the input circuit has been closed.
- ▶ Monitored reset: Unit is active once the input circuit is closed and once the reset circuit is closed after the waiting period has elapsed (see technical details).
- ▶ Increase in the number of available contacts by connecting contact expander modules or external contactors/relays.

Timing diagram

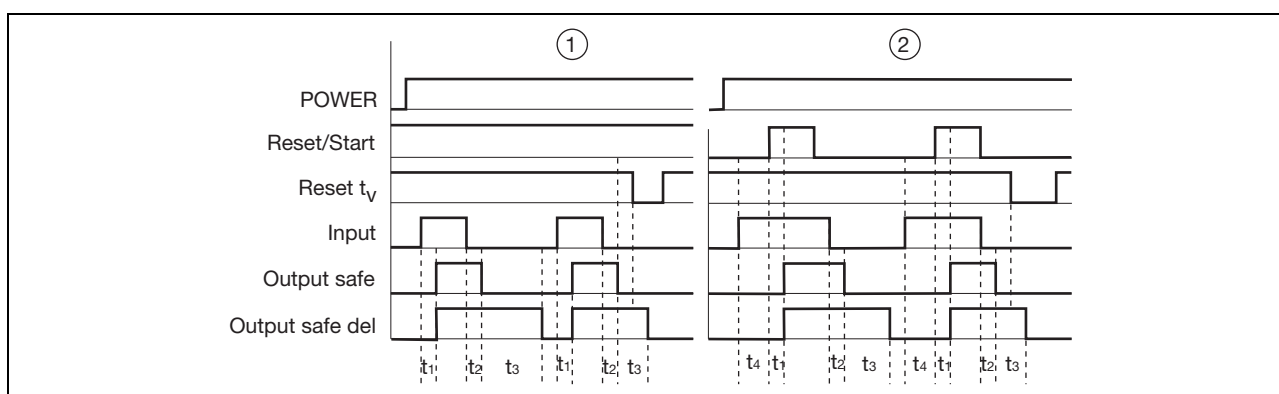

Key

- ▶ Power: Supply voltage
- ▶ Reset/start: Reset circuit S13-S14, S33-S34
- ▶ Reset t_v : Y39-Y40
- ▶ Input: Input circuits S11-S12, S21-S22, S31-S32
- ▶ Output safe: Safety contacts, instantaneous 13-14, 23-24
- ▶ Output safe del: Safety contacts, delayed 37-38, 47-48
- ▶ ①: Automatic reset
- ▶ ②: Monitored reset
- ▶ t_1 : Switch-on delay
- ▶ t_2 : Delay-on de-energisation
- ▶ t_3 : Delay time
- ▶ t_4 : Waiting period

Wiring

Please note:

- ▶ Information given in the “Technical details” must be followed.
- ▶ Outputs 13-14, 23-24 are instantaneous safety contacts, outputs 37-38, 47-48 are delay-on de-energisation safety contacts.
- ▶ To prevent contact welding, a fuse should be connected before the output contacts (see technical details).
- ▶ Calculation of the max. cable runs l_{max} in the input circuit:

$$l_{max} = \frac{R_{lmax}}{R_l / km}$$

R_{lmax} = max. overall cable resistance (see technical details)

R_l / km = cable resistance/km

- ▶ Use copper wire that can withstand 60/75 °C.

- ▶ Sufficient fuse protection must be provided on all output contacts with capacitive and inductive loads.

Up to Category 4, EN 954-1 PNOZ XV2P

Preparing for operation

► Supply voltage

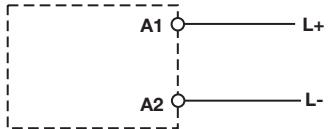
Supply voltage	AC	DC
		

► Input circuit

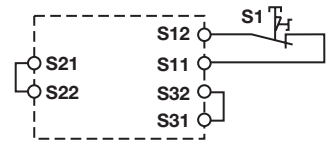
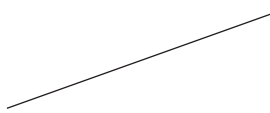
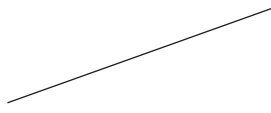
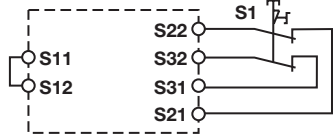
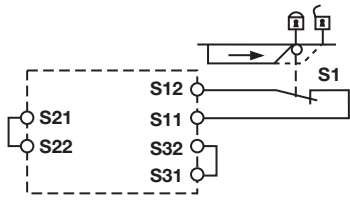
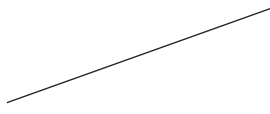
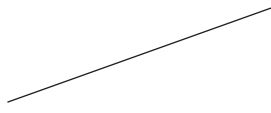
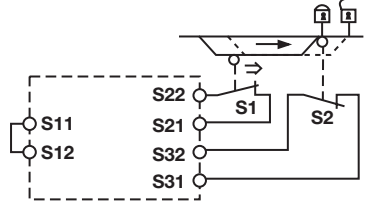
Input circuit	Single-channel	Dual-channel
E-STOP without detection of shorts across contacts		
E-STOP with detection of shorts across contacts		
Safety gate without detection of shorts across contacts		
Safety gate with detection of shorts across contacts		

Up to Category 4, EN 954-1 PNOZ XV2P

▶ Reset circuit

Reset circuit	E-STOP wiring (single-channel) Safety gate (single-channel)	E-STOP wiring (dual-channel) Safety gate (dual-channel)
Automatic reset		
Monitored reset		



▶ Feedback loop

Feedback loop	Automatic reset	Monitored reset
Contacts from external contactors		

▶ Reset delay time

Reset	Without reset	With reset
Link or N/C contact		

▶ Key

S1/S2	E-STOP pushbutton/ safety gate switch
S3	Reset button
	Switch operated
	Gate open
	Gate closed

Up to Category 4, EN 954-1 PNOZ XV2P

Terminal configuration

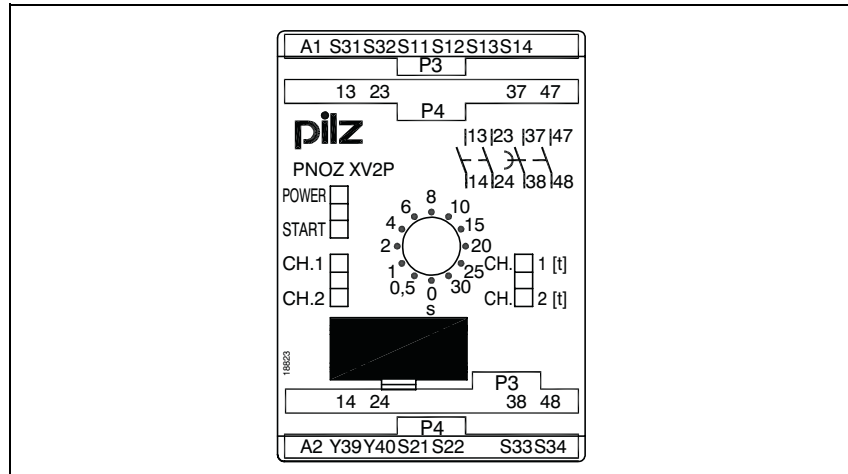

Installation

- ▶ The safety relay should be installed in a control cabinet with a protection type of at least IP54.
- ▶ Use the notch on the rear of the unit to attach it to a DIN rail.
- ▶ Ensure the unit is mounted securely on a vertical DIN rail (35 mm) by using a fixing element (e.g. retaining bracket or an end angle).

Dimensions

* with cage clamp terminals

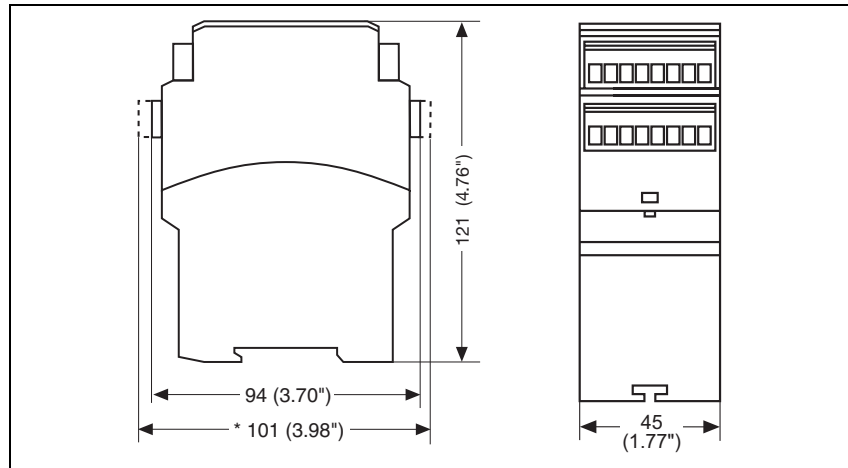

Up to Category 4, EN 954-1 PNOZ XV2P

Notice

This data sheet is only intended for use during configuration. For installation and operation, please refer to the operating instructions supplied with the unit.

Service life graph

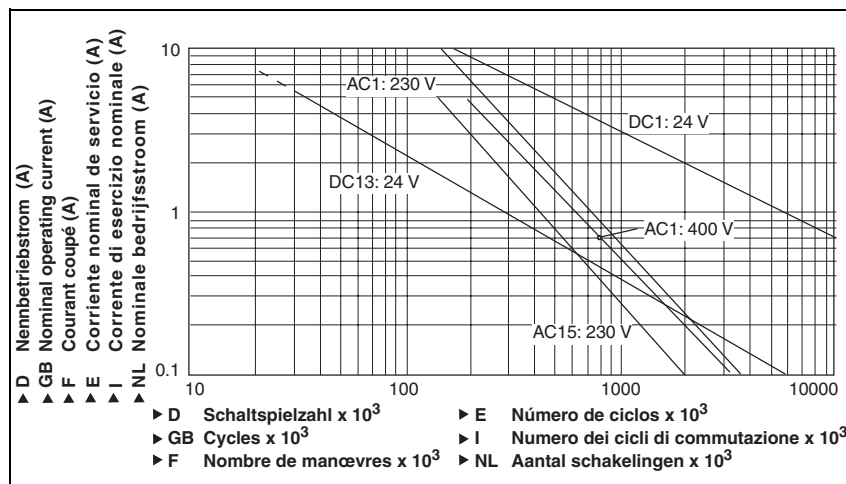

Technical details

Electrical data

Supply voltage U_B DC	24 V
Voltage tolerance	-15 % / +10 %
Power consumption at U_B DC	4.5 W
Residual ripple DC	160 %
Voltage and current at input circuit: 24 VDC reset circuit: 24 VDC feedback loop: 24 VDC	40.0 mA 40.0 mA 40.0 mA
Output contacts in accordance with EN 954-1 , Category 4 Output contacts in accordance with EN 954-1 Category 1 Order no. 777500, 787500 Category 3	Safety contacts (N/O): 2 ST Safety contacts (N/O), delayed: 2 ST If delay time >30 s If delay time <30 s
Utilisation category in accordance with EN 60947-4-1 AC1: 240 V	I_{min} : 0.01 A , I_{max} : 8.0 A P_{max} : 2000 VA
DC1: 24 V	I_{min} : 0.01 A , I_{max} : 8.0 A P_{max} : 200 W
Utilisation category in accordance with EN 60947-5-1 AC15: 230 V DC13 (6 cycles/min): 24 V	I_{max} : 5.0 A I_{max} : 7.0 A
Contact material	AgSnO₂ + 0.2 µm Au
External contact fuse protection (EN 60947-5-1) Blow-out fuse, quick Blow-out fuse, slow Circuit breaker	10 A 6 A 6 A , 24 VAC/DC, characteristic B/C
Max. overall cable resistance R_{lmax} input circuits, reset circuits Single-channel at U_B DC Dual-channel with detect. of shorts across contacts at U_B DC	100 Ohm 10 Ohm

Up to Category 4, EN 954-1 PNOZ XV2P

Times	
Switch-on delay	
with automatic reset typ.	350 ms
with automatic reset max.	650 ms
with automatic reset after power on typ.	385 ms
with automatic reset after power on max.	700 ms
with monitored reset typ.	35 ms
with monitored reset max.	70 ms
Delay-on de-energisation	
with E-STOP typ.	15 ms
with E-STOP max.	30 ms
with power failure typ.	85 ms
with power failure max.	200 ms
Recovery time at max. switching frequency 1/s after E-STOP	50 ms
after power failure	250 ms
Delay time t_v selectable	0.10 s, 0.20 s, 0.30 s, 0.40 s, 0.50 s, 0.60 s, 0.70 s, 0.80 s, 1.00 s, 1.50 s, 2.00 s, 3.00 s Order no.: 777502, 787502
	0.00 s, 0.50 s, 1.00 s, 2.00 s, 4.00 s, 6.00 s, 8.00 s, 10.00 s, 15.00 s, 20.00 s, 25.00 s, 30.00 s Order no.: 774500, 787500
	0.5 s Order no.: 777504, 787504 1.0 s Order no.: 777503, 787503
Fixed	
Repetition accuracy	2 %
Time accuracy	-15 % / +15 % +50 ms
Waiting period with a monitored reset	300 ms
Simultaneity, channel 1 and 2	∞
Supply interruption before de-energisation	20 ms
Environmental data	
EMC	EN 60947-5-1, EN 61000-6-2
Vibration in accordance with EN 60068-2-6	
Frequency	10 - 55 Hz
Amplitude	0.35 mm
Climatic suitability	EN 60068-2-78
Airgap creepage	VDE 0110-1
Ambient temperature	-10 - 55 °C
Storage temperature	-40 - 85 °C
Protection type	
Mounting (e.g. cabinet)	IP54
Housing	IP40
Terminals	IP20
Mechanical data	
Housing material	
Housing	PPO UL 94 V0
Front	ABS UL 94 V0
Max. cross section of external conductors with screw terminals	
1 core flexible	0.25 - 2.50 mm²
2 core, same cross section, flexible:	
with crimp connectors, without insulating sleeve	0.25 - 1.00 mm²
without crimp connectors or with TWIN crimp connectors	0.20 - 1.50 mm²
Torque setting with screw terminals	0.50 Nm
Max. cross section of external conductors with cage clamp terminals: Flexible without crimp connectors	0.2 - 1.5 mm²
Cage clamp terminals	
Terminal points per connection	2
Stripping length	8 mm
Dimensions (H x W x D)	
with screw terminals	94 mm x 45 mm x 121 mm
with cage clamp terminals	101 mm x 45 mm x 121 mm
Weight	360 g Order no. 777502, 777500
	350 g Order no. 787502, 787500, 777504, 777503
	340 g Order no. 787504, 787503

Up to Category 4, EN 954-1 PNOZ XV2P

The standards current on **11/03** apply.

Max. continuous current

Number of contacts	I_{\max} (A) at U_B DC
1	8.00 A
2	7.00 A
3	5.70 A
4	5.00 A

Order reference

Type	Features	Terminals	Order no.
PNOZ XV2P	24 VDC	30 s selectable	Screw terminals 777 500
PNOZ XV2P C	24 VDC	30 s selectable	Cage clamp terminals 787 500
PNOZ XV2P	24 VDC	3 s selectable	Screw terminals 777 502
PNOZ XV2P C	24 VDC	3 s selectable	Cage clamp terminals 787 502
PNOZ XV2P	24 VDC	1 s fixed	Screw terminals 777 503
PNOZ XV2P C	24 VDC	1 s fixed	Cage clamp terminals 787 503
PNOZ XV2P	24 VDC	0.5 s fixed	Screw terminals 777 504
PNOZ XV2P C	24 VDC	0.5 s fixed	Cage clamp terminals 787 504