

Category 3, EN 954-1 PNOZ 4

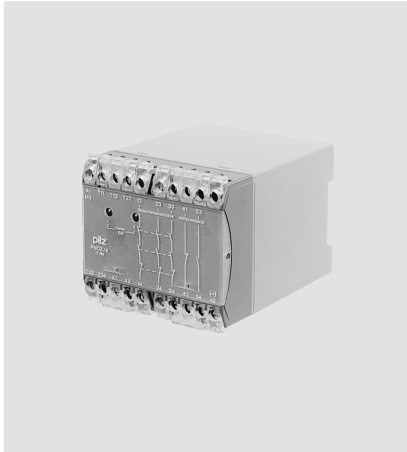

Emergency stop relay and safety gate monitor in accordance with VDE 0113, EN 60 204-1 and IEC 204-1.

Features

- Single-channel or dual-channel without the detection of shorts across the input contacts
- Supply voltage: 24 VDC
- 1 N/O contact as auxiliary contact

Approvals

	PNOZ 4
	●
	●
INRS	●
	●
	●

Technical Details	PNOZ 4
Electrical Data	
Supply Voltage	24 VDC
Tolerance	85 ... 110 %
Power Consumption	Approx. 8 W
Voltage and Current at the Input and Reset Circuits and Feedback Control Loop	24 VDC, 85 mA
Switching Capability in accordance with EN 60 947-4-1	AC1: 240 V/8 A/2000 VA, 400 V/5 A/2000 VA DC1: 24 V/8 A/200 W
EN 60 947-5-1 (DC13: 6 cycles/min.)	AC15: 230 V/5 A; DC13: 24 V/7 A
Output Contacts	3 safety contacts (N/O) 2 auxiliary contacts (1 N/O + 1 N/C)
Contact Fuse Protection (EN 60 947-5-1)	10 A quick or 6 A slow
Times	
Delay-on Energisation	Max. 900 ms
Delay-on De-energisation	Max. 50 ms
Recovery Time	Approx. 100 ms
Simultaneity channel 1/2	∞
Max. Supply Interruption before De-energisation	Approx. 10 ms
Mechanical Data	
Max. Cross Section of External Conductors	2 x 2.5 mm ² Single-core or multi-core with crimp connectors
Dimensions (H x W x D)	75 x 90 x 110 mm
Weight	420 g

Description

- 90 mm P-75 housing, DIN Rail mounting
- Positive-guided relay outputs:
 - 3 safety contacts (N/O)
 - 1 auxiliary contact (N/C)
 - 1 auxiliary contact (N/O)
- Connections for
 - E-STOP button
 - safety gate limit switch
 - reset button
- LED for channel 1/2
- Increase in the number of safety contacts available by connecting expander modules.

Operating Modes

- Single-channel operation
- Dual-channel operation
- Automatic reset
- Manual reset

Category 3, EN 954-1 PNOZ 4

Internal Wiring Diagram

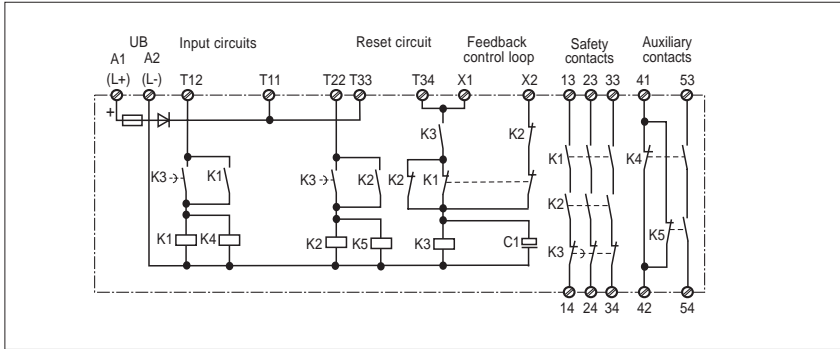

- Key

- S1/2: E-STOP or safety gate switch
- S3: Reset button
- ↑ Switch operated
- 🔒 Gate open
- 🔒 Gate closed

● Increase in safety contacts
The number of output contacts can be increased by using expander modules or relays/contactors with positive-guided contacts

External Wiring

● Example 1
Single-channel E-STOP wiring with manual reset.

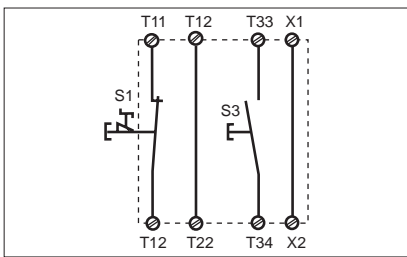

● Example 4
Dual-channel safety gate control with manual reset, simultaneity: x

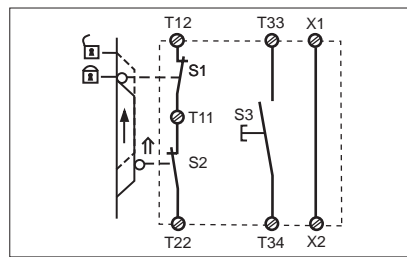

● Example 2
Dual-channel E-STOP wiring with manual reset.

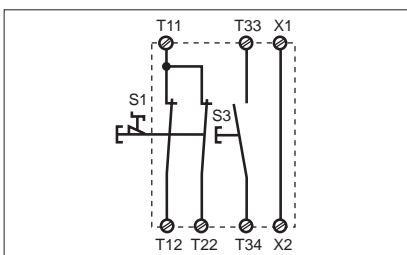

● Example 5
Dual-channel safety gate control with automatic reset.

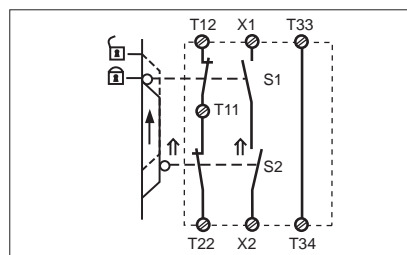

● Example 3
Single-channel safety gate control with manual reset.

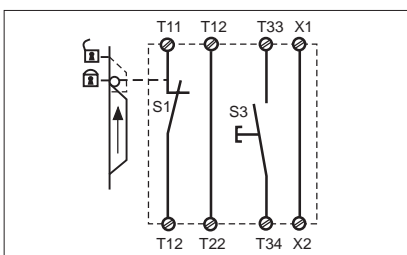

● Example 6
Dual-channel safety gate control with automatic reset while simultaneity is maintained.

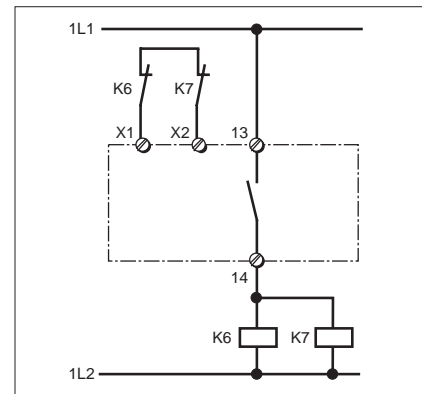
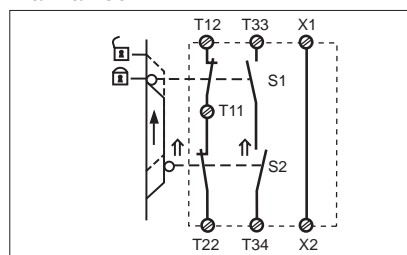

Category 3, EN 954-1 PNOZ 4

General Technical Data

Unless stated otherwise in the technical details for the specific unit

Electrical Data

Frequency Range AC	50 ... 60 Hz
Residual Ripple DC	160 %
Contact Material	AgSnO ₂
Continuous Duty	100 %

Environmental Data

EMC	EN 50081-1, 01/92, EN 50082-2, 03/95
Vibration in accordance with EN 60068-2-6, 04/95	Frequency: 10 ... 55 Hz, Amplitude: 0.35 mm
Climatic Suitability	IEC 60068-2-3, 1969
Airgap Creepage	DIN VDE 0110 part1, 04/97
Ambient Temperature	-10 ... +55 °C
Storage Temperature	-40 ... +85 °C

Mechanical Data

Torque Setting on Connection Terminals	0.6 Nm (screws)
Mounting Position	Any
Housing Material	Thermoplast Noryl SE 100
Protection	Mounting: IP 54 Housing: IP 40 Terminal Range: IP 20