

## Category 4, EN 954-1 PNOZ X3



Emergency stop relay and safety gate monitor in accordance with VDE 0113, 11/98, EN 60204-1, 12/97 and IEC 204-1, 11/98, safety component in accordance with the Lift Directive 95/16/EC and EN 81-1/1998

### Features

- Monitored manual or automatic reset can be selected
- 1 semiconductor output (K1/K2)
- Each AC unit can be operated with 24 VDC
- Safety gate function with N/C-N/O combination
- Only dual-channel operation will detect shorts across the input contacts

### Approvals

	PNOZ X3
	●
	●
	●
	●

Technical Details	PNOZ X3
<b>Electrical Data</b>	
Supply Voltage	AC: 24, 42, 48, 110, 115, 120, 230, 240 V DC: 24 V
Tolerance	85 ... 110 %
Power Consumption	Approx. 2.5 W/5 VA
Voltage and Current at the Input and Reset Circuits and Feedback Control Loop	24 VDC, 35 mA
Switching Capability in accordance with EN 60947-4-1, 10/91	AC1: 240 V/8 A/2000 VA DC1: 24 V/8 A/200 W
EN 60947-5-1, 10/91 (DC13: 6 cycles/min.)	AC15: 230 V/5 A; DC13: 24 V/6A
Output Contacts	3 safety contacts (N/O), 1 auxiliary contact (N/C)
Contact Fuse Protection (EN 60947-5-1, 10/91)	10 A quick or 6 A slow
Semiconductor Outputs	24 VDC/20 mA, short-circuit protected
External Supply Voltage	24 VDC ±20 %
<b>Times</b>	
Delay-on Energisation	Monitored manual reset: max. 100 ms Auto./ manual reset: max. 0.3 s
Delay-on De-energisation	With E-STOP: max. 80 ms With power failure: max. 1 s
Recovery Time	Approx. 1 s
Simultaneity channel 1/2	∞
Max. Supply Interruption before De-energisation	Approx. 25 ms
<b>Environmental Data</b>	
Ambient Temperature	-25 ... +55 °C
<b>Mechanical Data</b>	
Maximum Cross Section of External Conductors	2 x 1.5 mm <sup>2</sup> or 1 x 2.5 mm <sup>2</sup> Single-core or multi-core with crimp connectors
Dimensions (H x W x D)	87 x 45 x 121 mm
Weight	420 g

### Description

- 45 mm, P-93 housing, DIN-Rail mounting
- Positive-guided relay outputs:
  - 3 safety contacts (N/O)
  - 1 auxiliary contact (N/C)
- Connections for
  - E-STOP button
  - safety gate limit switch
  - reset button
- Semiconductor output signals ready for operation
- LEDs for channel 1, channel 2 and power
- Increase in the number of safety contacts available by connecting expander modules.

### Operating Modes

- Single-channel operation
- Dual-channel operation
- Automatic reset
- Monitored manual reset

## Category 4, EN 954-1 PNOZ X3

### Internal Wiring Diagram

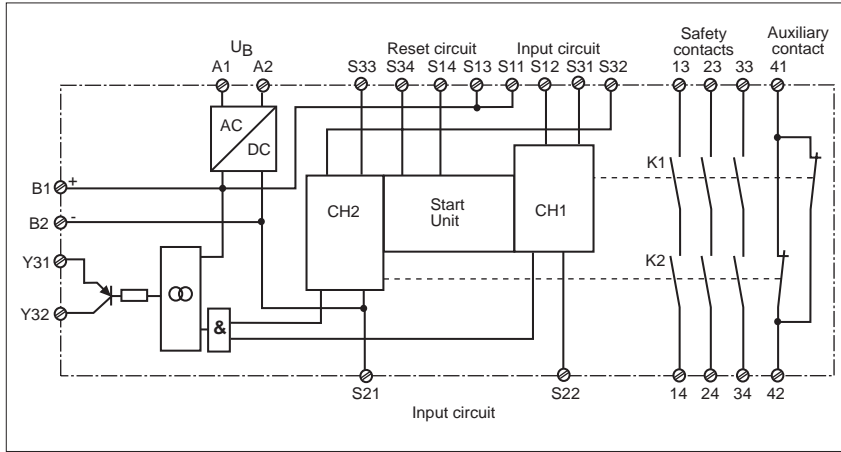

### External Wiring

● Example 1  
Single-channel E-STOP wiring with automatic reset.

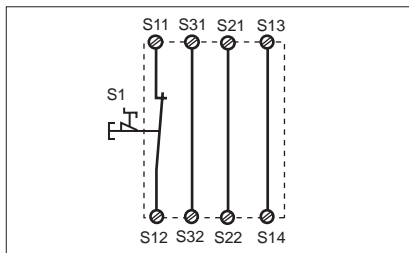

● Example 3  
Dual-channel E-STOP wiring with monitored manual reset.

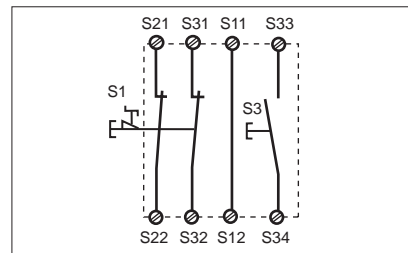

● Example 2  
Single-channel E-STOP wiring with monitored manual reset.

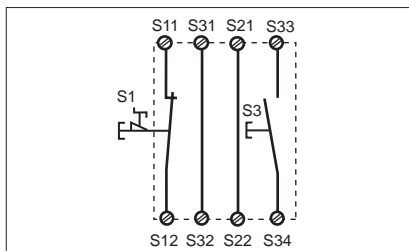

● Example 4  
Single-channel safety gate control with monitored manual reset.

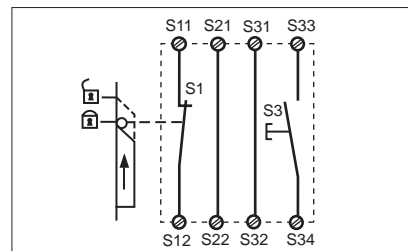

● Example 5  
Dual-channel safety gate control with monitored manual reset.

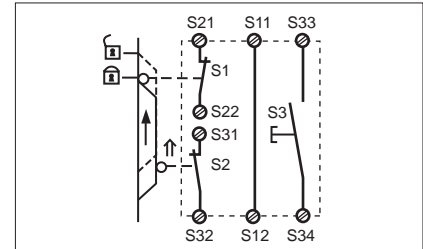

● Example 6  
Dual-channel safety gate control with automatic reset.

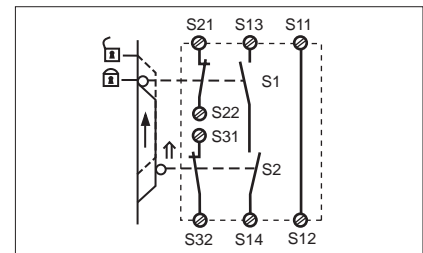

- Key

S1/2: E-STOP or safety gate switch

S3: Reset button

↑ Switch operated

🔓 Gate open

🔒 Gate closed

## Category 4, EN 954-1 PNOZ X3

● Increase in safety contacts  
The number of output contacts can be increased by using expander modules or relays/contactors with positive-guided contacts.

– Operation with automatic reset.

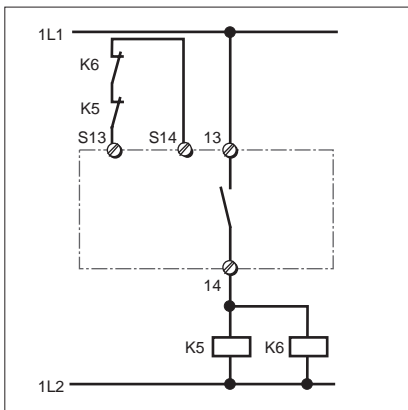

– Operation with monitored manual reset.

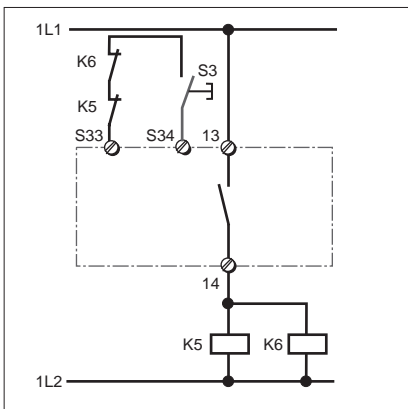

## Category 4, EN 954-1 PNOZ X3

### General Technical Data

Unless stated otherwise in the technical details for the specific unit

#### Electrical Data

Frequency Range AC	50 ... 60 Hz
Residual Ripple DC	160 %
Contact Material	AgSnO <sub>2</sub>
Continuous Duty	100 %

#### Environmental Data

EMC	EN 50081-1, 01/92, EN 50082-2, 03/95
Vibration in accordance with EN 60068-2-6, 04/95	Frequency: 10 ... 55 Hz, Amplitude: 0.35 mm
Climatic Suitability	DIN IEC 60068-2-3, 12/86
Airgap Creepage	DIN VDE 0110 part 1, 04/97
Ambient Temperature	-10 ... +55 °C
Storage Temperature	-40 ... +85 °C

#### Mechanical Data

Torque Setting on Connection Terminals	0.6 Nm (screws)
Mounting Position	Any
Housing Material	Thermoplast Noryl SE 100
Protection	Mounting: IP 54 Housing: IP 40 Terminal Range: IP 20

The units were tested in accordance with the relevant standards current at the time of development.

### Order References

Type	U <sub>B</sub>	Order No.
PNOZ X3	24 V AC/24 V DC	774 310
PNOZ X3	42 V AC/24 V DC	774 311
PNOZ X3	48 V AC/24 V DC	774 312
PNOZ X3	110 V AC/24 V DC	774 314
PNOZ X3	115 V AC/24 V DC	774 315
PNOZ X3	120 V AC/24 V DC	774 316
PNOZ X3	230 V AC/24 V DC	774 318
PNOZ X3	240 V AC/24 V DC	774 319