

Safe-Weigh® Process Weighing System



FEATURES

- Patented synchronization techniques for digitized load cells
- Proactive diagnostics assure system performance
- Dynamic digital filtering
- 1 million count resolution per load cell

OPTIONAL FEATURES

- 8 process setpoints
- Up to 4 analog current outputs
- DeviceNet, A-B Remote I/O, Modbus Plus, or Profibus interface capability

DESCRIPTION

The LCp-104 System's patented synchronous digital measurement of multi-cell systems establishes the new benchmark in scale technology. True parallel data processing, with each update, guarantees real time continuous weight measurement unheralded in process weighing. Until now, inherent load shifting during weighing cycles, mixing, or reactions have restricted performance of independent load cell measurement systems. With synchronous measurement, each system update is correctly summed and the benefits of individual measurement are retained.

LCp-104 Process Weighing Systems individually digitize each transducer in a multi-cell system and display the resultant weight signals, live, on the console display. Measuring each individual load cell provides greater system resolution and accuracy, while facilitating on-line dynamic diagnostics throughout the system process. Unique diagnostic 'look-ahead' profiles alert operating personnel to potential system malfunctions, before they happen.

Dynamic Digital Filtering maximizes display stability and setpoint cutoff accuracy.

APPLICATIONS

- Quality critical batch and blend systems
- Reactor vessels
- High value ingredient/product processing
- Fault tolerant - no down time requirements

CONFIGURATION

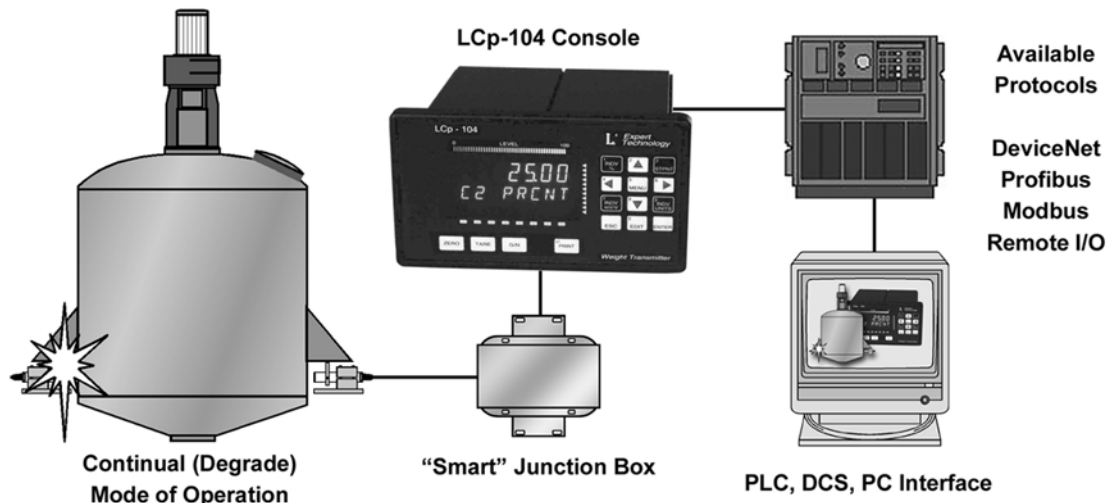

L⁴ TECHNOLOGY BASED DIGITAL WEIGHT PROCESSING

Sigma Delta A-D Conversion

Very high-resolution weight data is obtained by using an individual Sigma Delta A-D converter for each transducer input. This new technology uses a high-speed integrator coupled with digital signal processing to produce a precision of up to one part in 1,000,000.

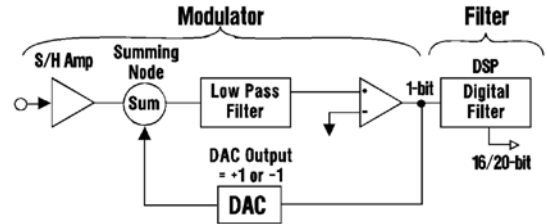

Intuitive Digital Filter

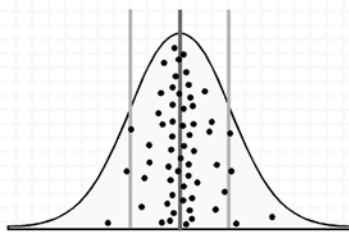

Combining new A-D technology with multi-channel control produces extremely precise internal weight information. Resultant data is sampled and evaluated statistically to determine the sample mean and standard deviation. This vital information is then used to optimize filter averaging and filter cutoff bands to maximize both data stability and response to true weight changes.

Multi-Channel, Synchronous Signal Processing

A patented method to control the timing of several dependent A-D converters with a single microprocessor allows for the use of individual transducer data without accumulated errors due to mass moving within a vessel. This capability makes it possible to individually digitize each transducer in a multi-cell system and achieve the benefits of additive resolution and system redundancy.

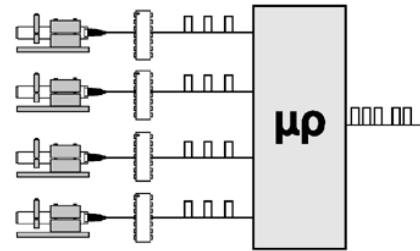

Expert System Diagnostics

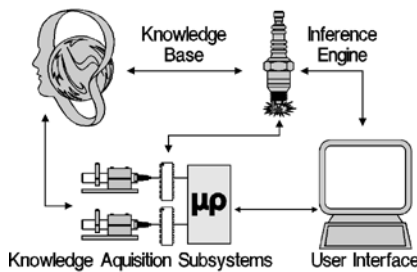

The LCp-104 uses the expert system concept to compare various measurements against known standards of acceptable performance and uses that relative comparison to identify and diagnose both transducer and system performance problems. The BLH expert system identifies piping influences, structural problems, transducer drift, cell overload, and the location and characteristics of process noise.

Individual Load Cell 'LIVE' Displays

Viewing individual load cells live, throughout the entire process, allows operating personnel to profile system trends or tendencies and adjust equipment for maximum performance. Although the total system may never overload, certain cells may experience overload or underload 'moments' which can affect cell integrity, longevity, and ultimately, product quality.

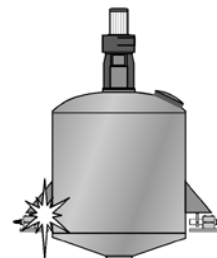

OUTLINE DIMENSIONS

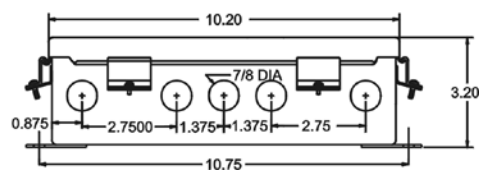
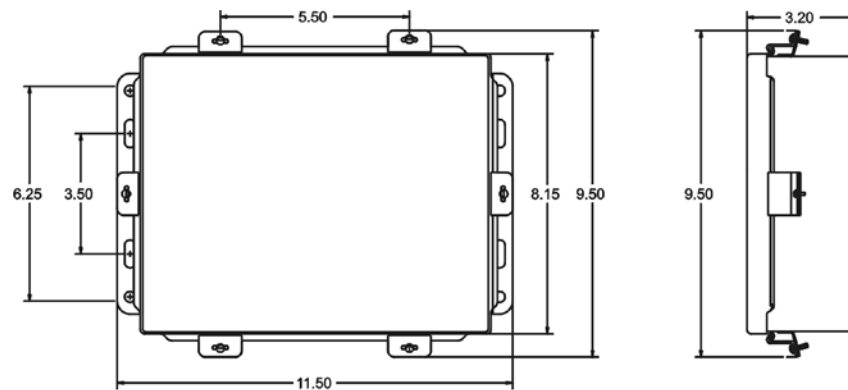
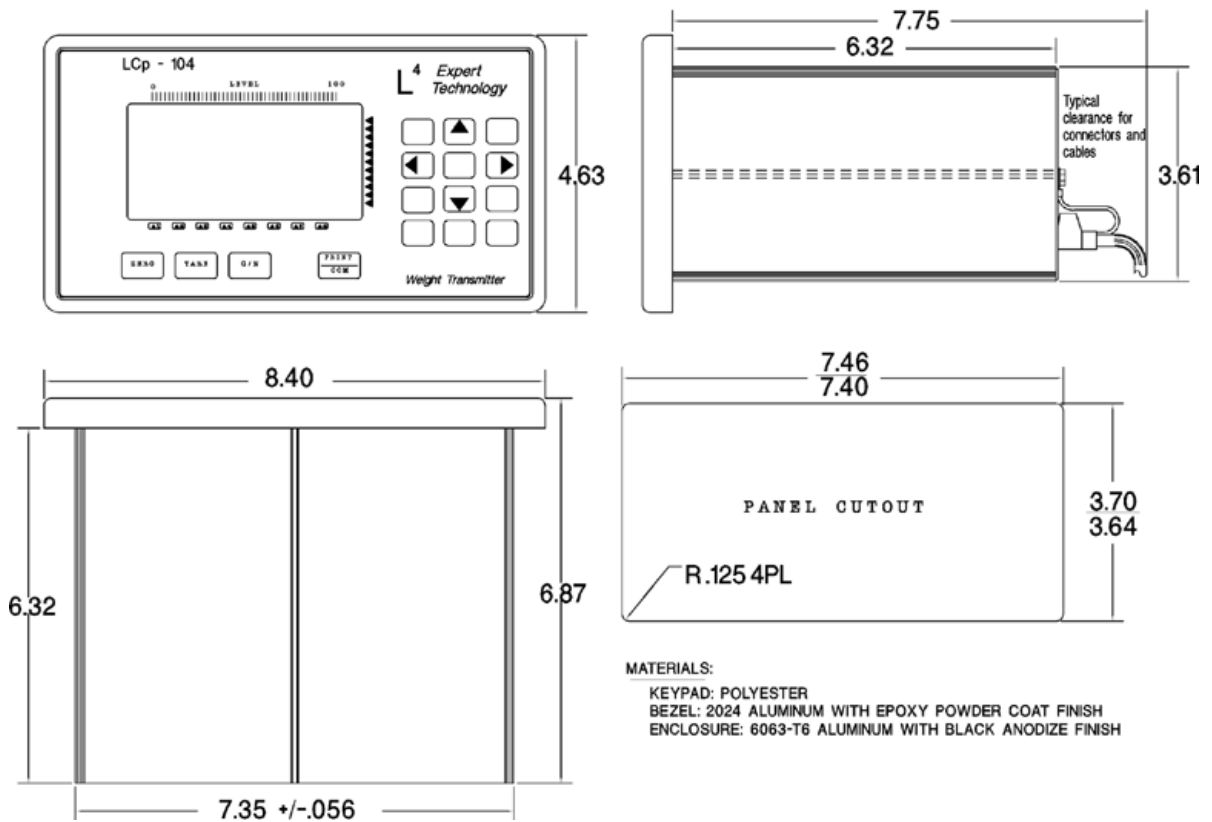

SPECIFICATIONS

PERFORMANCE

Internal Resolution	4,194,304 total counts
Max. Display Resolution	3,000,000 total counts
Max. Res. Per Channel	1,000,000 counts
Conversion Speed	33 msec (30 updates/sec)
Sensitivity (Noise)	0.001 1% full scale (max) (max ±16 counts w/o filter)
Full Scale Range	35 mV/channel
Dead Load Range	100%
Linearity	±0.0015% of full scale
Load Cell Excitation	10 V (65 mA/channel max)
Software Filter (Std.)	50 to 10,000 msec
Temperature Effects:	
Zero	±2 ppm/°C
Span	±7 ppm/°C
Remote Sense	user configurable, each channel
Calibration Repeatability	0.3 µV per count

ENVIRONMENT

Operating Temperature	-10 to 55°C (12 to 131°F)
Storage Temperature	-20 to 85°C (-4 to 185°F)
Humidity	5 to 90% rh, non-condensing

DISPLAY/OPERATOR INTERFACE

Type	high intensity cobalt green vacuum fluorescent
Active Digits	7 digit alpha numeric .59" high for weight: 8 digit alphanumeric .39" high for status

ELECTRICAL

Voltage	117/230 Vac +15% 50/60 Hz
Power	12 watts max
Input Impedance	10 M-Ohms, min. per channel
Step Response	one conversion cycle
Common Mode Rej.	100 db @ 60 Hz

ISOLATED ANALOG OUTPUT (4 MAX, OPTIONAL)

Type	16 bit digital to analog
Current	4-20 mA (600 ohm max load)

DIGITAL INPUTS

Logic'0' (Low) (min)	less than 0.5 Vdc, sink 3 mA
Logic'1' (High) collector)	10 to 28 Vdc (TTL open
Mechanical Relay'0'	closed (one side = digital common, the other side = input)
Mechanical Relay'1'	open (input internally pulled up)

DC SETPOINT OUTPUTS - 8 (STANDARD)

Type	open collector (current sinking)
Operating Voltage	5 - 35 Vdc
ON Voltage	1.2 Vdc @ 40 mA 0.8 Vdc @ 1 mA
OFF State Leakage Power	0.04 µA @ 40 Vdc external supply required

AC SETPOINT OUTPUTS - 8 (OPTIONAL)

Type	triac
Operating Voltage	12 -240 Vac
AC Frequency	20 - 500 Hz
ON State Voltage Drop	1.2 Vrms
Min - Max Load Current	5 mA - 1 A
Leakage Current	1 mA @ full rated load voltage
Power	external supply required

NETWORK SERIAL COMMUNICATION (STANDARD)

Type	RS-485 Half Duplex (Multi-Drop)
Baud	9.6K, 28.8K and 56.7K
Data Format	proprietary

SIMPLEX DATA OUTPUT (STANDARD)

Type	RS-485 (Simplex)
Baud	1200 or 9600
Data Format (Selectable)	
ASCII	7 data bits, even parity, stop bit

TERMINAL/COMPUTER INTERFACE (OPTIONAL)

Interface Type	RS-485 half duplex (standard)
Baud	1200 or 9600
Protocol	duplex command/response format
ASCII	7 data bits, even parity, stop bit

SPECIAL PROTOCOLS (OPTIONAL)

Modbus	RTU Protocol
--------	--------------

SPECIAL INTERFACE (OPTIONAL)

Allen Bradley	Remote I/O - 1/4 logical rack
Modbus Plus	peer-to-peer (with global data)
Profibus	slave
DeviceNet	slave

ENCLOSURE

Dimensions (Console)	4.63 x 8.40 x 6.5 in. HxWxD
Weight (Console)	5.4 lb
Dimensions (J-Box)	9.5 x 11.5 x 3.2 in. HxWxD
Weight (J-Box)	5.6 lb

APPROVALS

FM (Factory Mutual)	3611 (Class I, II, III; Div.1,2; Groups A-G)
CSA	C22.2 (Class I, II, III; Div.1,2; Groups A-G)

NOTE:

PLC and Allen-Bradley are trademarks of Allen-Bradley Co., Inc.
Modbus is a trademark of Schneider Automation.
Profibus is a trademark of Siemens.
DeviceNet is a trademark of ODVA
Safe-Weigh is a trademark of BLH

BLH is continually seeking to improve product quality and performance. Specifications may change accordingly.

Disclaimer

All product specifications and data are subject to change without notice.

Vishay Precision Group, Inc., its affiliates, agents, and employees, and all persons acting on its or their behalf (collectively, "Vishay Precision Group"), disclaim any and all liability for any errors, inaccuracies or incompleteness contained herein or in any other disclosure relating to any product.

Vishay Precision Group disclaims any and all liability arising out of the use or application of any product described herein or of any information provided herein to the maximum extent permitted by law. The product specifications do not expand or otherwise modify Vishay Precision Group's terms and conditions of purchase, including but not limited to the warranty expressed therein, which apply to these products.

No license, express or implied, by estoppel or otherwise, to any intellectual property rights is granted by this document or by any conduct of Vishay Precision Group.

The products shown herein are not designed for use in medical, life-saving, or life-sustaining applications unless otherwise expressly indicated. Customers using or selling Vishay Precision Group products not expressly indicated for use in such applications do so entirely at their own risk and agree to fully indemnify Vishay Precision Group for any damages arising or resulting from such use or sale. Please contact authorized Vishay Precision Group personnel to obtain written terms and conditions regarding products designed for such applications.

Product names and markings noted herein may be trademarks of their respective owners.