

SAVE ENERGY SAVE EARTH



LED DOWNLIGHT 9W

High efficiency LED lamp, over 110 lm/W one pcs.

Ra>75, Cool white, and warm white at option.

Step-sharpe glare-proof ring design offers good glare control and take away stray light.

Twin rings structure enhances the angle adjustment degree, satisfying different need for light beams.

Pure aluminum body has good heat dissipation.

Widely used in Jewelry display, musem, cosmetic display, hotels and other commercial site/centres.



DIMENSION

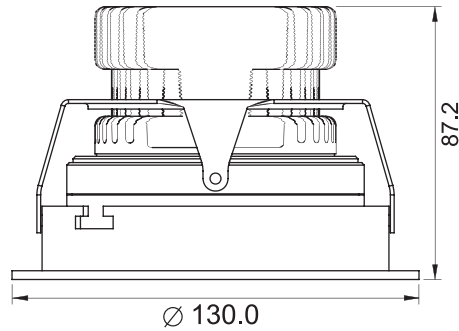

SPECIFICATION

Parameter	Specification	Units
Power Consumption	9	W
Input	DC 350	mA
Material	Aluminum	--
Field Angles	16°	Degree
CRI	80 / 75	--
Cut off	Ø116	mm.



ILLUMINANCE AND FIELD ANGLE

- Cool White / Warm White

Product Code	Power Consumption	Field Angle	Color	CCT	CRI
30D0500009GC020N	9 W	16°	Cool White	5,600K ±10%	>75
30D0500009GW020N		16°	Warm White	2,700K ±10%	>80

LIGHT PATTERN

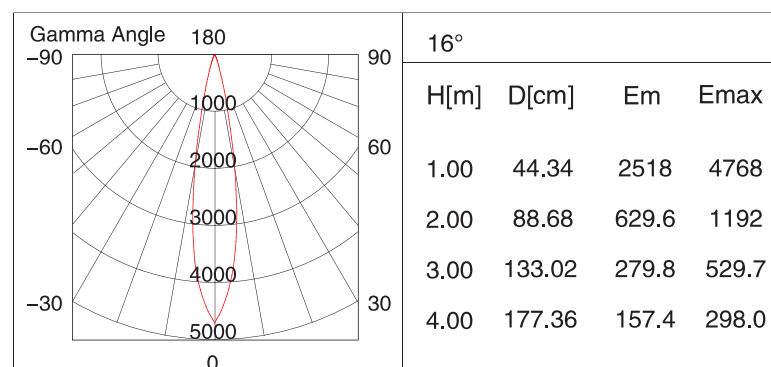

SPECIFICATION OF RECOMMENDED DRIVER

Input Voltage	Output Voltage	Operating Current (Constant)	PF
AC 220 ~ 240V	DC 30 ~ 72V	350 mA	0.8