



## Standstill PSWZ X1P



Standstill monitor for safe standstill monitoring

### Approvals

PSWZ X1P	
	◆
	◆
	◆

### Unit features

- ▶ Positive-guided relay outputs:
  - 2 safety contacts (N/O), instantaneous
  - 1 auxiliary contact (N/C), instantaneous
- ▶ LED indicator for:
  - Supply voltage
  - Standstill on channel 1/2
  - Switch status
  - Fault signal if simultaneity time is exceeded
- ▶ Semiconductor outputs signal:
  - Error
  - Switch status
- ▶ Semiconductor input for reset function
- ▶ Measuring inputs for single or three-phase motors
- ▶ Measuring voltage selectable
- ▶ Feedback loop
- ▶ Plug-in connection terminals (either cage clamp terminal or screw terminal)
- ▶ See order reference for unit types

### Unit description

The unit is used for safe standstill monitoring. It is designed for use on

- ▶ Standstill monitoring on plants with dangerous machine parts or tools (EN 1088 clause 7.4),
  - ▶ Safety circuits in accordance with EN 60204-1 and IEC 60204-1.
- Standstill is only detected on power-free measuring circuits. Residual voltages, induced voltages or drives within the position control will prevent safe standstill detection!

### Safety features

- ▶ Relays K1 and K2 are interlocked in such a way that the unit cannot be switched back on in the case of contact welding or an open circuit.
- ▶ The unit monitors the measuring circuits for open circuit. If an open circuit occurs between the unit and the motor or on the motor itself, the unit immediately switches off.
- ▶ The standstill monitor prevents the plant from being enabled in the following cases
  - Power supply failure
  - Component failure
  - Measuring circuits are open circuit
  - Coil defect/open circuit

### Block diagram

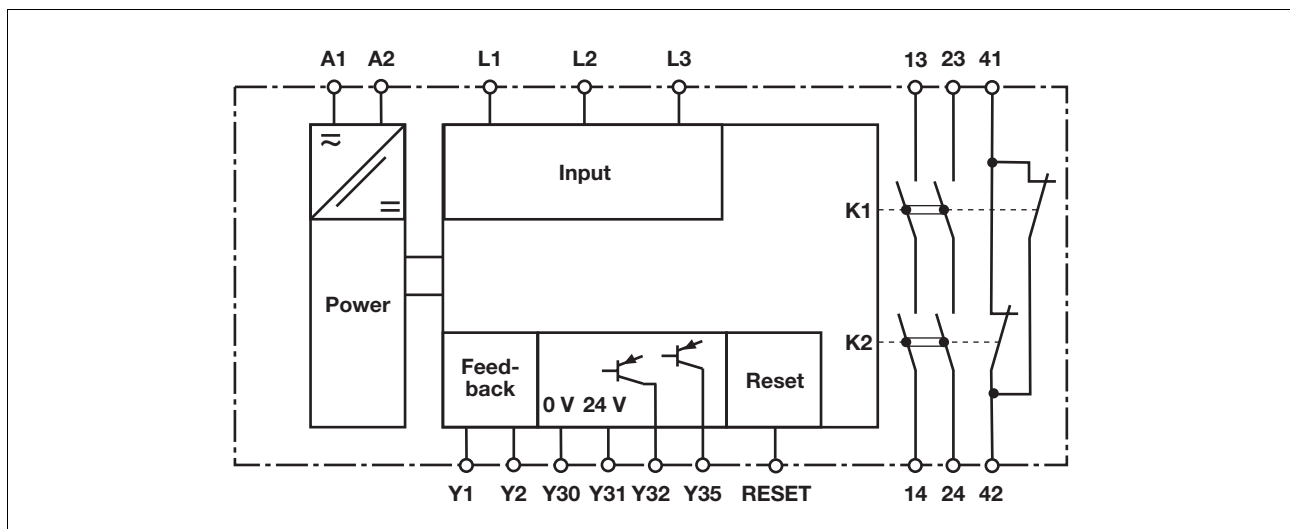

## Standstill PSWZ X1P

### Function description

The device uses two separate measuring channels to measure the regenerated voltage, induced from the motor during the rundown period or during start-up. If the voltage falls below the set response value (standstill threshold), the standstill monitor enables the monitored plant. If the voltage exceeds the set release value, the standstill monitor disables the monitored plant.

To reactivate, the voltage at both channels must fall below the response value  $U_{on}$  within the time  $t_g$  (simultaneity monitoring). To do this the feedback loop Y1-Y2 must be closed. If the

simultaneity requirement is exceeded, the standstill monitor does not enable the monitored plant. The unit can be reactivated by switching 24 VDC on and off at the RESET input.

The response value  $U_{on}$  can be set jointly for both channels in order to suit the motor that is to be monitored. The release value  $U_{off}$  (hysteresis) corresponds to twice the response value.

When used with frequency converters, the PSWZ X1P cannot detect standstill until the controller inhibit has been switched off.

After the supply voltage is switched on, the unit performs a self test. The unit simulates a situation in which the release value is exceeded and the

measuring circuit has an open circuit. The correct function of the output relay and feedback loop is also tested. The test takes ca. 1.5 s.

Operating modes:

- ▶ Single-channel operation:
  - One measuring circuit affects both channels
  - No redundancy (failsafe) in the measuring circuits
- ▶ Dual-channel operation:
  - Two redundant (identical) measuring circuits affect channel 1 and 2
  - Monitoring of voltages in the measuring circuit (failsafe in the event of a short circuit)

### Timing diagram

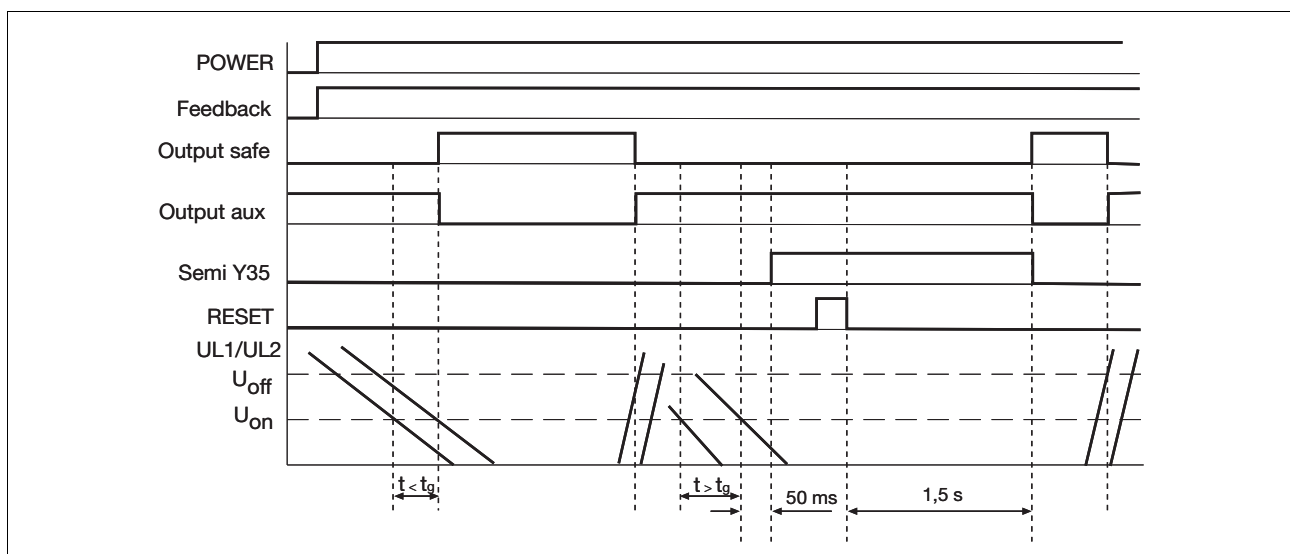

### Key

- ▶ POWER: Supply voltage
- ▶ UL1/UL2: Input circuit L1, L2, L3
- ▶ Feedback: Feedback loop Y1-Y2
- ▶ Output safe: Safety contacts 13-14, 23-24
- ▶ Output aux: Auxiliary contact 41-42
- ▶ Semi Y35: Semiconductor output for fault signal
- ▶ RESET: Reset input RESET
- ▶  $U_{on}$ : Response value
- ▶  $U_{off}$ : Release value
- ▶  $t_g$ : Simultaneity

### Wiring

Please note:

- ▶ Information given in the "Technical details" must be followed.
- ▶ Outputs 13-14, 23-24 are safety contacts, output 41-42 is an auxiliary contact (e.g. for display).
- ▶ To prevent contact welding, a fuse should be connected before the

- output contacts (see technical details).
- ▶ Use copper wire that can withstand 60/75 °C.
- ▶ When used with converters: Use screened cable for the wiring between the standstill monitor and the

motor. Connect the cable screening on the motor.

## Standstill PSWZ X1P

### Preparing for operation

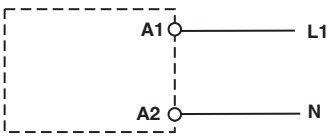
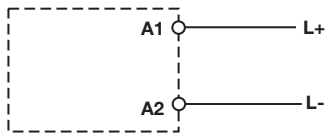

#### ▶ Supply voltage

Supply voltage	AC	DC
		

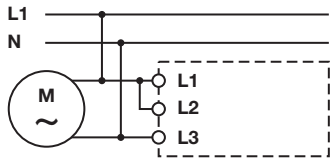
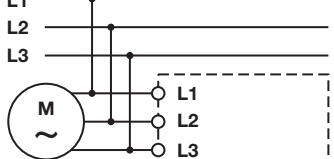
#### ▶ Input circuit

Input circuit	Single-phase motor	Three-phase motor
		

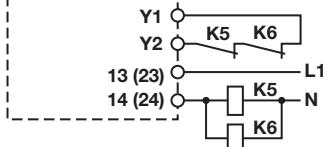
#### ▶ Feedback loop

Contacts from external contactors or link		
		

#### ▶ Semiconductor output

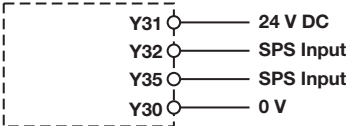
Y32: Semiconductor output for switch status Y35: Semiconductor output for fault signal	
---	--

#### ▶ Semiconductor input

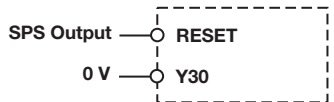
---

## Standstill PSWZ X1P

### Terminal configuration

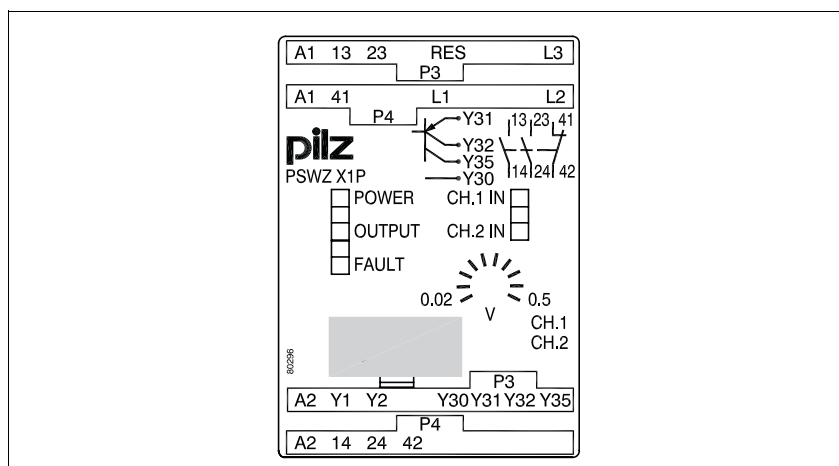

### Installation

- ▶ The safety relay should be installed in a control cabinet with a protection type of at least IP54.
- ▶ Use the notch on the rear of the unit to attach it to a DIN rail.
- ▶ Ensure the unit is mounted securely on a vertical DIN rail (35 mm) by using a fixing element (e.g. retaining bracket or an end angle).

### Dimensions

\* with cage clamp terminals

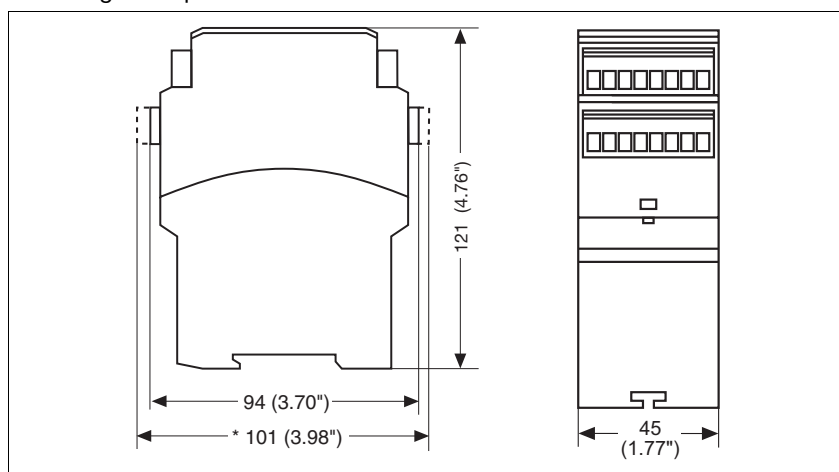

## Standstill PSWZ X1P

### Notice

This data sheet is only intended for use during configuration. For installation and operation, please refer to the operating instructions supplied with the unit.

### Service life graph

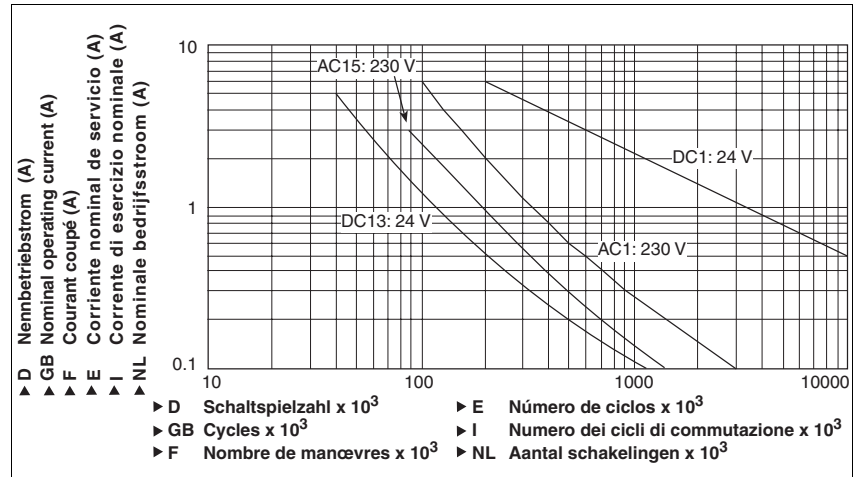

### Technical details

#### Electrical data

Supply voltage	
Supply voltage $U_B$ AC/DC	<b>24 - 240 V</b>
Voltage tolerance	<b>-15 %/+10 %</b>
Power consumption at $U_B$ AC	<b>5.0 VA</b>
Power consumption at $U_B$ DC	<b>3.0 W</b>
Frequency range AC	<b>50 - 60 Hz</b>
Residual ripple DC	<b>160 %</b>
Voltage and current at Feedback loop DC: <b>24.0 V</b>	<b>35.0 mA</b>
Number of output contacts	
Safety contacts (S) instantaneous:	<b>2</b>
Auxiliary contacts (N/C):	<b>1</b>
Category of output contacts in accordance with <b>EN 954-1</b>	
Safety contacts (S) instantaneous:	<b>4</b>
Utilisation category in accordance with <b>EN 60947-4-1</b>	
Safety contacts: AC1 at <b>240 V</b>	$I_{min}: 0.01 A, I_{max}: 6.0 A$ $P_{max}: 1500 VA$
Safety contacts: DC1 at <b>24 V</b>	$I_{min}: 0.01 A, I_{max}: 6.0 A$ $P_{max}: 150 W$
Auxiliary contacts: AC1 at <b>240 V</b>	$I_{min}: 0.01 A, I_{max}: 6.0 A$ $P_{max}: 1500 VA$
Auxiliary contacts: DC1 at <b>24 V</b>	$I_{min}: 0.01 A, I_{max}: 6.0 A$ $P_{max}: 150 W$
Utilisation category in accordance with <b>EN 60947-5-1</b>	
Safety contacts: AC15 at <b>230 V</b>	$I_{max}: 3.0 A$
Safety contacts: DC13 at <b>24 V</b> (6 cycles/min)	$I_{max}: 4.0 A$
Auxiliary contacts: AC15 at <b>230 V</b>	$I_{max}: 3.0 A$
Auxiliary contacts: DC13 at <b>24 V</b> (6 cycles/min)	$I_{max}: 4.0 A$
Contact material	<b>AgCuNi + 0.2 µm Au</b>

## Standstill PSWZ X1P

<b>Electrical data</b>	
External contact fuse protection ( $I_k = 1 \text{ kA}$ ) to <b>EN 60947-5-1</b>	
Blow-out fuse, quick	
Safety contacts:	<b>6 A</b>
Auxiliary contacts:	<b>6 A</b>
Blow-out fuse, slow	
Safety contacts:	<b>4 A</b>
Auxiliary contacts:	<b>4 A</b>
Circuit breaker 24 VAC/DC, characteristic B/C	
Safety contacts:	<b>4 A</b>
Auxiliary contacts:	<b>4 A</b>
Semiconductor outputs (short circuit proof)	<b>24.0 V DC, 50 mA</b>
External supply voltage	<b>24.0 V DC</b>
Voltage tolerance	<b>-20 %/+20 %</b>
Semiconductor input	
High	<b>15 VDC</b>
Low	<b>5 VDC</b>
Input current	<b>20 mA</b>
Measuring circuit	
Input voltage L1-L3, L1-L2, L2-L3	<b>0 – 690 VAC/DC</b>
Input voltage in accordance with UL	<b>0 – 600 VAC</b>
Frequency range	<b>0 – 3000 Hz</b>
Input impedance	<b>1300 kOhm</b>
Switching threshold per channel	
Response value $U_{on}$	<b>7,5 – 500 mV</b> Order no.: 777951, 787951 <b>20 – 500 mV</b> Order no.: 777949, 787949 <b>120 – 3000 mV</b> Order no.: 777950, 787950
Release value $U_{off}$	<b>2 x <math>U_{on}</math></b>
Max. inrush current:	<b>10 A, max. 20 ms</b>
<b>Times</b>	
Switch-on delay at motor standstill	
Max.	<b>1,500 ms</b>
After power on max.	<b>2,200 ms</b>
Delay-on de-energisation after motor on max.	<b>170 ms</b>
Recovery time at max. switching frequency 1/s after power failure	
	<b>2200 ms</b>
Simultaneity, channel 1 and 2	<b>7 s</b>
Supply interruption before de-energisation	<b>20 ms</b>
<b>Environmental data</b>	
EMC	<b>EN 60947-5-1, EN 61000-6-2, EN 61000-6-4</b>
Vibration to <b>EN 60068-2-6</b>	
Frequency	<b>10 – 55 Hz</b>
Amplitude	<b>0.35 mm</b>
Climatic suitability	<b>EN 60068-2-78</b>
Airgap creepage	<b>EN 60947-1</b>
Ambient temperature	<b>-10 – 55 °C</b>
Storage temperature	<b>-40 – 85 °C</b>
Protection type	
Mounting (e.g. cabinet)	<b>IP54</b>
Housing	<b>IP40</b>
Terminals	<b>IP20</b>
<b>Mechanical data</b>	
Housing material	
Housing	<b>PPO UL 94 V0</b>
Front	<b>ABS UL 94 V0</b>

## Standstill PSWZ X1P

Mechanical data	
Max. cross section of external conductors with screw terminals 1 core flexible	<b>0.25 - 2.50 mm<sup>2</sup> , 24 - 14 AWG</b> Order no.: 777949, 777950, 777951
2 core, same cross section, flexible: with crimp connectors, without insulating sleeve	<b>0.25 - 1.00 mm<sup>2</sup> , 24 - 16 AWG</b> Order no.: 777949, 777950, 777951
without crimp connectors or with TWIN crimp connectors	<b>0.50 - 1.50 mm<sup>2</sup> , 24 - 16 AWG</b> Order no.: 777949, 777950, 777951
Torque setting with screw terminals	<b>0.60 Nm</b> Order no.: 777949, 777950, 777951
Max. cross section of external conductors with cage clamp terminals/spring-loaded terminals: Flexible without crimp connectors	<b>0.20 - 1.50 mm<sup>2</sup> , 24 - 16 AWG</b> Order no.: 787949, 787950, 787951
Cage clamp terminals/spring-loaded terminals: Terminal points per connection	<b>2</b> Order no.: 787949, 787950, 787951
Stripping length	<b>8 mm</b> Order no.: 787949, 787950, 787951
Dimensions	
Height	<b>101.0 mm</b> Order no.: 787949, 787950, 787951 <b>94.0 mm</b> Order no.: 777949, 777950, 777951
Width	<b>45.0 mm</b>
Depth	<b>121.0 mm</b>
Weight	<b>315 g</b> Order no.: 787949, 787950, 787951 <b>320 g</b> Order no.: 777949, 777950, 777951

The standards current on **03/05** apply.

Order reference				
Type	Features		Terminals	Order no.
PSWZ X1P C	24 - 240 VAC/DC	0,02 - 0.5 V	Cage clamp terminals	787 949
PSWZ X1P	24 - 240 VAC/DC	0,02 - 0.5 V	Screw terminals	777 949
PSWZ X1P C	24 - 240 VAC/DC	0,12 - 3 V	Cage clamp terminals	787 950
PSWZ X1P	24 - 240 VAC/DC	0,12 - 3 V	Screw terminals	777 950
PSWZ X1P C	24 - 240 VAC/DC	0,0075 - 0,5 V	Cage clamp terminals	787 951
PSWZ X1P	24 - 240 VAC/DC	0,0075 - 0,5 V	Screw terminals	777 951