

Category 4, EN 954-1 PNOZ XV3.1P



Emergency stop relay and safety gate monitor in accordance with EN 60204-1 (VDE 0113 part 1), 12/97 and IEC 60204-1, 10/97

Features

- Dual-channel wiring with detection of shorts across the input contacts
- Monitored manual or automatic reset can be selected
- 2 delay-off safety contacts
- Supply voltage: 24 ... 240 V AC/DC
- Supply voltage: 24 V DC
- Plug-in connection terminals

Approvals

	PNOZ XV3.1P
	●
	●
	●

Technical Details	PNOZ XV3.1P
Electrical Data	
Supply Voltage	DC: 24 V DC AC/DC: 24 V ... 240 V
Tolerance	85 ... 110 %
Power Consumption U_b	DC: Approx. 4,5 W AC/DC: Approx. 11 VA/5.5 W
Voltage and Current at the Input and Reset Circuits and Feedback Control Loop	DC: 24 V DC, 50 mA AC/DC: 22 V DC, 50 mA
Switching Capability in accordance with EN 60947-4-1, 02/01	AC1: 240 V/0,03...5 A/1200 VA DC1: 24 V/0,03...5 A/120 W
EN 60947-5-1, 11/97 (DC13: 6 cycles/min.)	AC15: 230 V/5 A; DC13: 24 V/3 A
Output Contacts	2 delayed safety contacts (N/O) 1 auxiliary contact (N/C) 3 instantaneous safety contacts (N/O)
Contact fuse protection according to EN 60947-5-1, 11/97	Blow-out fuse: 6 A quick or 4 A slow Safety cut-out: 24 V DC: 6 A, Characteristic B/C
EMC	EN 61000-6-3, 10/01, EN 61000-6-2, 10/01
Times	
Delay-on-De-Energisation 57-58, 67-68	Adjustable: 0,1-3 s: 0.1/0.2/0.3/0.4/0.5/0.6/0.7/0.8/1/1.5/2/3 s 0-30 s: 0/0.5/1/2/4/6/8/10/15/20/25/30 s 0-300 s: 0/5/10/20/40/60/80/100/150/200/250/300 s Fixed: 0.5 s/3 s/10 s
Switch-on delay	Monitored Reset: Max. 100 ms Automatic or manual Reset: Max. 0.5 s
Delay-on De-energisation	Max. 50 ms
Recovery Time	Approx. 1 s
Simultaneity channel1/2	∞
Max. Supply Interruption before De-energisation	Approx. 25 ms
Mechanical Data	
Maximum cross section of ext. conductors	
Single-core	Flexible, without crimp connectors: 0.2 ... 2.5 mm ² Flexible with crimp connectors: 0.25 ... 2.5 mm ²
Multi-core (2 conductors with same cross-section)	Flexible, with crimp connectors but without plastic sheath: 0.25 ... 1 mm ² Flexible, with TWIN-crimp connectors and plastic sheath: 0.5 ... 1.5 mm ²
Torque setting for connection terminals	0.5 ... 0.6 Nm (screws)
Dimensions (H x W x D)	94 x 90 x 121 mm
Weight	DC: 510 g AC/DC: 595 g

Category 4, EN 954-1 PNOZ XV3.1P

Description

- 90 mm P-99 housing, DIN Rail mounting
- Positive-guided relay outputs:
 - 3 instantaneous safety contacts (N/O)
 - 1 auxiliary contact (N/C)
 - 2 delayed safety contacts (N/O)
- Connections for
 - E-STOP button
 - safety gate limit switch
 - reset button
- LEDs for power, channel 1, channel 2, reset circuit
- Increase in the number of safety contacts available by connecting expander modules.

Operating Modes

- Single-channel operation
- Dual-channel operation
- Automatic reset
- Monitored manual reset

Internal Wiring Diagram

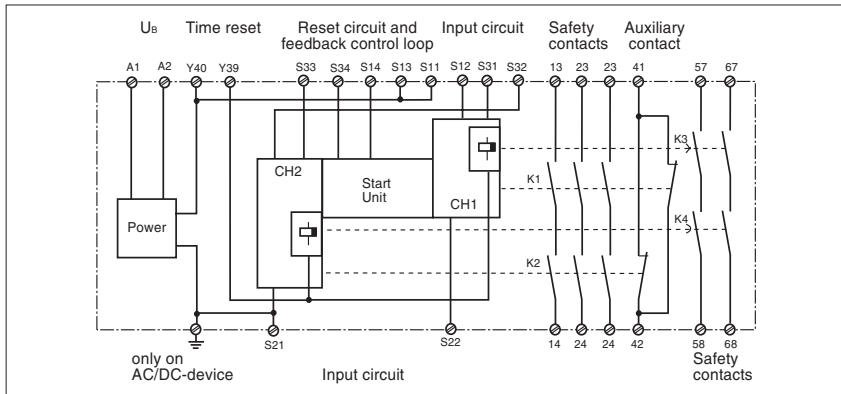

External Wiring

- Example 1
Single-channel E-STOP wiring with automatic reset.

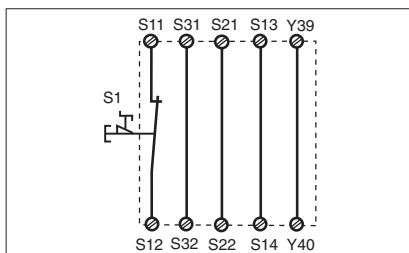

- Example 2
Single-channel E-STOP wiring with monitored manual reset.

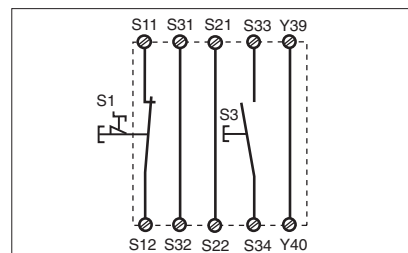

- Example 3
Dual-channel E-STOP wiring with monitored manual reset.

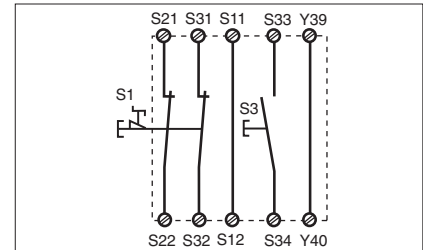

- Example 4
Single-channel safety gate control with monitored manual reset.

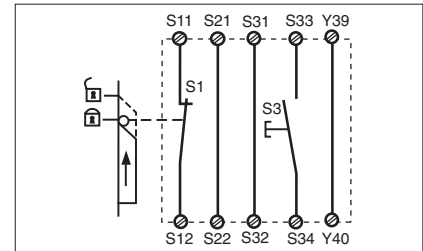

- Example 5
Dual-channel safety gate control with monitored manual reset.

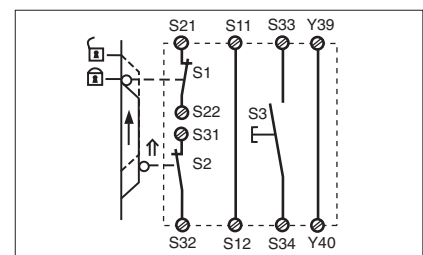

- Example 6
Dual-channel safety gate control with automatic reset.

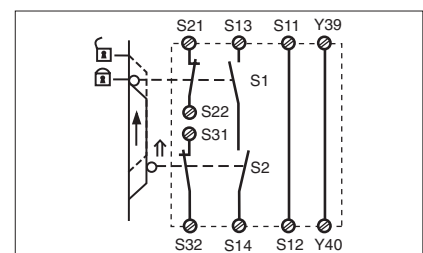

Category 4, EN 954-1 PNOZ XV3.1P

– Key

S1/2:	E-STOP or safety gate switch
S3:	Reset button
↑↑	Switch operated
	Gate open
	Gate closed

● Increase in safety contacts

The number of output contacts can be increased by using expander modules or relays/contactors with positive-guided contacts.

– Operation with automatic reset.

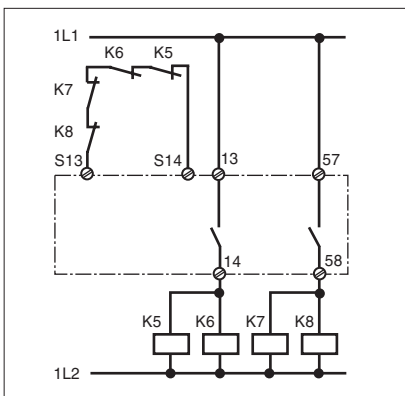

– Operation with monitored manual reset.

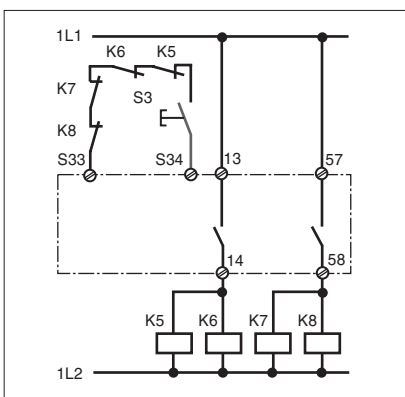

Category 4, EN 954-1 PNOZ XV3.1P

General Technical Data

Unless stated otherwise in the technical details for the specific unit

Electrical Data

Frequency Range AC	50 ... 60 Hz
Residual Ripple DC	160 %
Contact Material	AgSnO ₂
Continuous Duty	100 %

Environmental Data

EMC	EN 50081-1, 01/92, EN 61000-6-2, 10/01
Vibration in accordance with EN 60068-2-6, 04/95	Frequency: 10 ... 55 Hz, Amplitude: 0.35 mm
Climatic Suitability	DIN IEC 60068-2-3, 12/86
Airgap Creepage	DIN VDE 0110-1, 04/97
Ambient Temperature	-10 ... +55 °C
Storage Temperature	-40 ... +85 °C

Mechanical Data

Torque Setting on Connection Terminals	0.6 Nm (screws)
Mounting Position	Any
Housing Material	Thermoplast Noryl SE 100
Protection	Mounting: IP 54 Housing: IP 40 Terminal Range: IP 20

The units were tested in accordance with the relevant standards current at the time of development.

Order References

Type No.	t	U _B	Order
PNOZ XV3.1P	0,5 s fixed	24 V DC	777 524
PNOZ XV3.1P	3 s fixed	24 V DC	777 525
PNOZ XV3.1P	10 s fixed	24 V DC	777 527
PNOZ XV3.1P	3 s adjustable	24 V DC	777 522
PNOZ XV3.1P	30 s adjustable	24 V DC	777 520
PNOZ XV3.1P	300 s adjustable	24 V DC	777 528
PNOZ XV3.1P	0,5 s fixed	24 V ... 240 V AC/DC	777 534
PNOZ XV3.1P	3 s fixed	24 V ... 240 V AC/DC	777 535
PNOZ XV3.1P	10 s fixed	24 V ... 240 V AC/DC	777 537
PNOZ XV3.1P	3 s adjustable	24 V ... 240 V AC/DC	777 532
PNOZ XV3.1P	30 s adjustable	24 V ... 240 V AC/DC	777 530
PNOZ XV3.1P	300 s adjustable	24 V ... 240 V AC/DC	777 538