

Category 4, EN 954-1 PNOZ X4



EMERGENCY STOP switchgear and safety gate monitor according to VDE 0113-1, 11/98, EN 60204-1, 12/97 and IEC 60204-1, 11/98

Features

- either monitored, unmonitored or automatic start possible
- 1-channel or 2-channel wiring with or without shorts across contacts detection

Approvals

	PNOZ X4
	●
	●
	●

Technical data	PNOZ X4
Electrical data	
Power supply	AC: 24, 42, 48, 110, 115, 120, 230, 240 V DC: 24 V
Tolerance	85 ... 110 %
Power consumption	Approx. 4.5 VA/2 W
Voltage and current at input, start and feedback loop	24 V DC, 40 mA
Output contacts	3 safety contacts (NO) 1 auxiliary contact (NC)
Switching capability according to EN 60947-4-1, 10/91	AC1: 240 V/8 A/2000 VA DC1: 24 V/8 A/200 W
EN 60947-5-1, 10/91 (DC13:6 cycles/min)	AC15: 230 V/5 A; DC13: 24 V/7 A
Contact protection according to EN 60947-5-1, 10/91	10 A quick or 6 A slow
Times	
Pickup delay	monitored start: max. 100 ms auto./man. start: max. 0,3 s
Delay-on de-energisation	at EMERGENCY STOP: max. 50 ms at mains off: max. 0,5 s
Recovery time	approx. 1 s
Simultaneity channel 1 and 2	∞
Power failure buffer	approx. 25 ms
Environmental data	
Ambient temperature	-25 ... +55 °C
Mechanical data	
Max. cross-section of outer conductor single wire or multi-wire with end ferrule	2 x 1.5 mm ² oder 1 x 2.5 mm ²
Dimensions (H x W x D)	87 x 45 x 121 mm
Weight	AC: 360 g, DC: 265 g

Description

- 45 mm P-97 housing, on standard rail, snap-on
- Relay outputs, positive-guided:
 - 3 safety contacts (NO)
 - 1 auxiliary contact (NC)
- Connection possibilities for
 - EMERGENCY STOP switch
 - Safety gate limit switch
 - Start switch
- LEDs for switching status Channel 1 and 2 and power supply
- Contact multiplication and Contact amplification possible by external contactors

Operating modes

- Single channel mode
- Dual channel mode without shorts across contacts detection
- Dual channel mode with shorts across contacts detection
- Automatic start
- Manual start without monitoring
- Manual start with monitoring

Category 4, EN 954-1 PNOZ X4

Schematic interior diagram

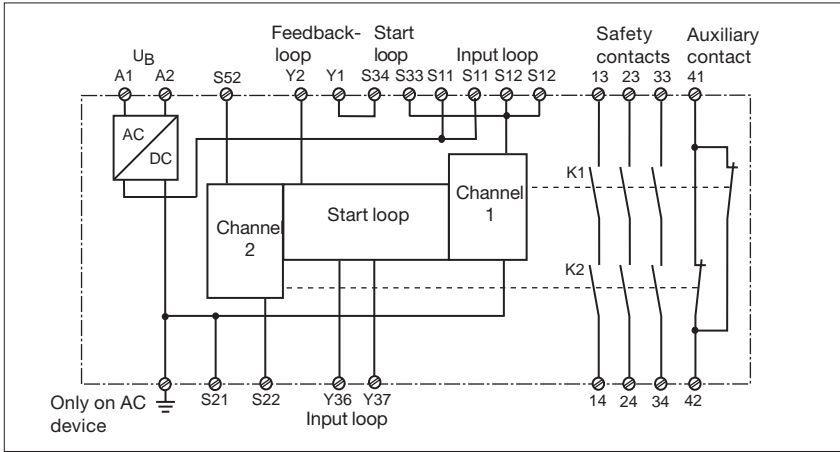

External wiring

● Example 1
Single-channel EMERGENCY STOP wiring with automatic start

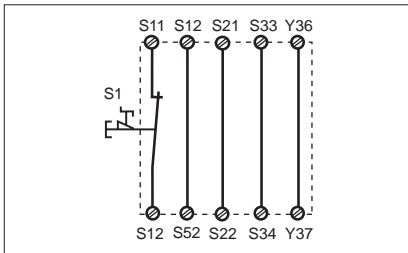

● Example 2
Single-channel EMERGENCY STOP wiring with unmonitored start

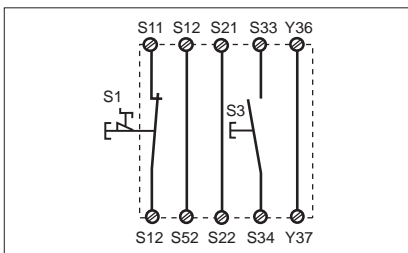

● Example 3
Dual-channel EMERGENCY STOP wiring with shorts across contacts detection with monitored start

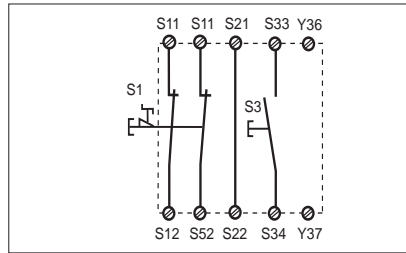

● Example 4
Single-channel safety gate control with unmonitored start

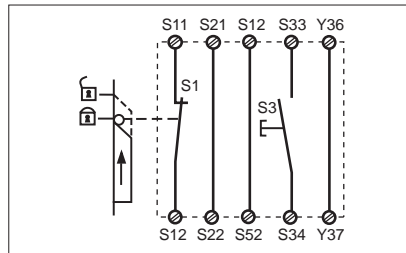

● Example 5
Dual-channel safety gate control without shorts across contacts detection with monitored start

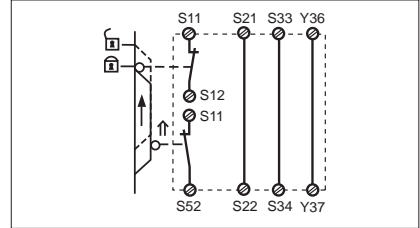

● Example 6
Dual-channel safety gate control with shorts across contacts detection and monitored start

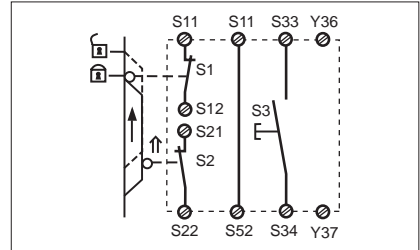

● Example 7
Dual channel light barrier control with shorts across contacts detection by BWS, with monitored start

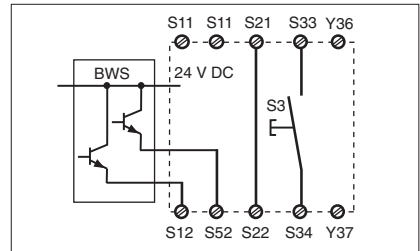

- Legend

- S1/S2: EMERGENCY STOP or safety gate switch
- S3: Start switch
- ↑ actuated element
- ⬜ gate not closed
- ⬜ gate closed

Category 4, EN 954-1 PNOZ X4

- Contact multiplication

The output contacts can be amplified or multiplied by external contactors with positive-guided contacts if necessary.

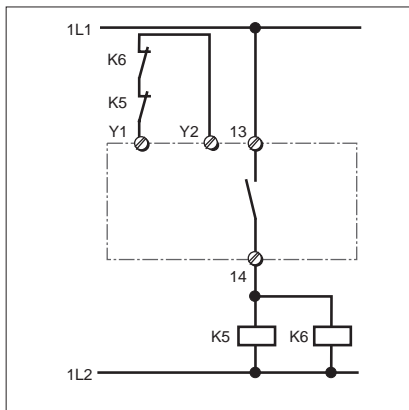

Category 4, EN 954-1 PNOZ X4

General Technical Data

Unless stated otherwise in the technical details for the specific unit

Electrical Data

Frequency Range AC	50 ... 60 Hz
Residual Ripple DC	160 %
Contact Material	AgSnO ₂
Continuous Duty	100 %

Environmental Data

EMC	EN 50081-1, 01/92, EN 50082-2, 03/95
Vibration in accordance with EN 60068-2-6, 04/95	Frequency: 10 ... 55 Hz, Amplitude: 0.35 mm
Climatic Suitability	DIN IEC 60068-2-3, 12/86
Airgap Creepage	DIN VDE 0110 part 1, 04/97
Ambient Temperature	-10 ... +55 °C
Storage Temperature	-40 ... +85 °C

Mechanical Data

Torque Setting on Connection Terminals	0.6 Nm (screws)
Mounting Position	Any
Housing Material	Thermoplast Noryl SE 100
Protection	Mounting: IP 54 Housing: IP 40 Terminal Range: IP 20

The units were tested in accordance with the relevant standards current at the time of development.

Order References

Type	U _B	Order No.
PNOZ X4	24 V DC	774 730
PNOZ X4	42 V AC	774 731
PNOZ X4	110 V AC	774 734
PNOZ X4	115 V AC	774 735
PNOZ X4	120 V AC	774 736
PNOZ X4	230 V AC	774 738
PNOZ X4	240 V AC	774 739