

Category 4, EN 954-1 PNOZ e1p



Emergency stop relay and safety gate monitor in accordance with VDE 0113-1, 11/98, EN 60204-1, 12/97 and IEC 204-1, 11/98

Features

- Monitored manual or automatic reset can be selected
- 2 safe semiconductor outputs
- 1 auxiliary semiconductor output
- Auxiliary output can also be used as a diagnostic output
- Option for detecting shorts across the input contacts
- Applications in accordance with EN 954-1, 07/96, category 2, 3 or 4
- Self-test after U_B is supplied
- Continuous self-monitoring
- Regular switch-off test of the safety outputs

Approval

	PNOZ e1p
	●
	●
	●

Technical details	PNOZ e1p
Electrical data	
Supply voltage	24 VDC
Tolerance	80 ... 125 %
Power consumption	no load: 2 W
Residual Ripple DC	20 %
Outputs	2 safety outputs 1 auxiliary output
Switching capability	$U_B \leq 26.5$ V: 2 outputs under load: 2 A/50 W 1 output under load: 2.7 A/70 W $U_B > 26.5$ V: 2 outputs under load: 1.5 A/40 W
Voltage and current at input and reset circuits and feedback control loop	24 VDC, 5 mA
auxiliary output and test pulse outputs	24 VDC/0.5 A
Times	
Delay-on energisation	manual reset: 180 ms automatic reset: 100 ms
Delay-on de-energisation	max. 35 ms
Switch-on delay	3 s (on initial reset once U_B is supplied)
Simultaneity channel 1/2	∞
Max. Supply Interruption before de-energisation	max. 20 ms
Environmental data	
Storage temperature	-25 ... 70 °C
Mechanical data	
Max. cross section of external conductor, single core	flexible without crimp connector: 0.2 ... 2.5 mm ² flexible with crimp connector: 0.25 ... 2.5 mm ²
multi-core conductor (2 conductors with identical cross section)	flexible with crimp connector without plastic sleeve: 0.25 ... 1 mm ² flexible with TWIN crimp connector with plastic sleeve: 0.5 ... 1.5 mm ²
Torque setting for terminals	0.5 ... 0.6 Nm (screws)
Dimensions (H x W x D)	87 x 22.5 x 121 mm
Weight	170 g

Category 4, EN 954-1 PNOZ e1p

Description

- 22.5 mm P-99 housing, DIN-Rail mounting
- Semiconductor outputs, short-circuit proof:
 - 2 safety outputs
 - 1 auxiliary output
 - 2 test pulse outputs
- Connections for
 - E-STOP button
 - safety gate limit switch
 - evaluation device for proximity switches
 - safety mats and connecting blocks made by Haake
 - Reset button
- Auxiliary output can also be used as a diagnostic output
It is possible to program the driver for reading diagnostic data yourself. However, the CD „PLC

Drivers for PNOZelog“ is also available. This contains pre-programmed drivers for the following controllers:
- SIMATIC S7

- LEDs for switching status and faults in channel 1/2 and for supply voltage
- Shorts across the input contacts are detected by means of test pulse outputs
- Increase in the number of safety contacts available by connecting expander modules

Operating modes

- Single-channel operation
- Dual-channel operation
- Automatic reset
- Monitored manual reset

Internal wiring diagram

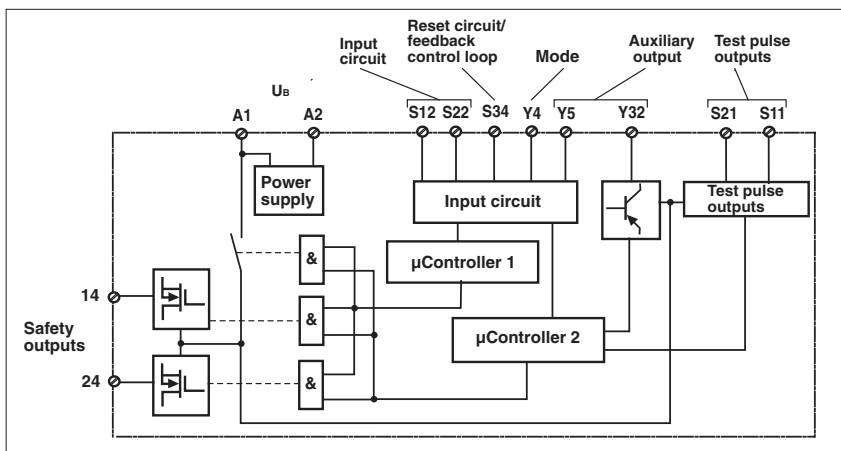

Category 4, EN 954-1 PNOZ e1p

External wiring

● Example 1

Single-channel emergency stop wiring with monitored manual reset without short-circuit recognition

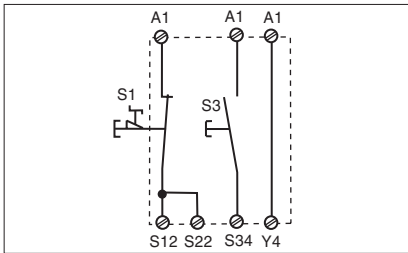

● Example 4

Dual-channel safety gate control with automatic reset without start-up test and without short-circuit recognition

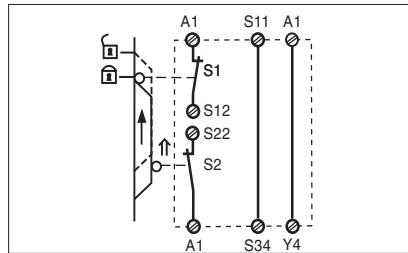

– Key

S1/S2:	E-STOP or safety gate switch
S3:	Reset button
	Switch operated
	Gate open
	Gate closed

● Example 2

Dual-channel emergency stop wiring with monitored manual reset without short-circuit recognition

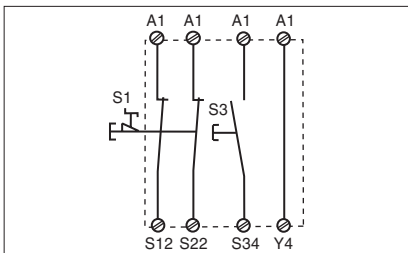

● Example 5

Dual-channel safety gate control with monitored manual reset without short-circuit recognition

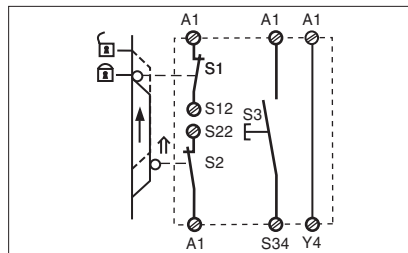

● Increase in the number of contacts

The number of output contacts can be increased by using expander modules or relays/contactors with positive-guided contacts.

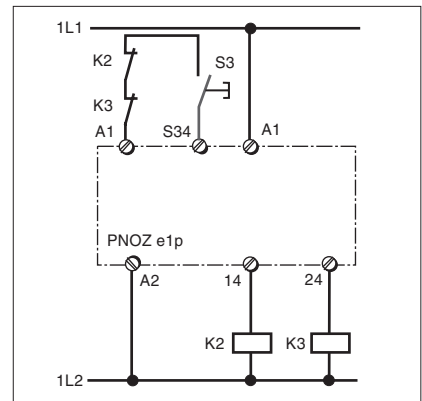

● Example 3

Dual-channel emergency stop wiring with monitored manual reset and shorts across the input contacts are detected

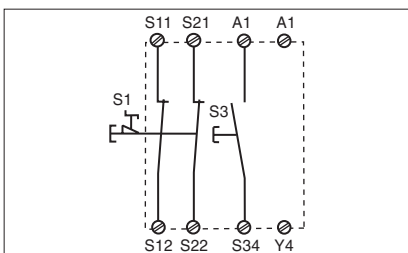

● Example 6

Dual-channel safety gate control with automatic reset and start-up test, shorts across the input contacts are detected

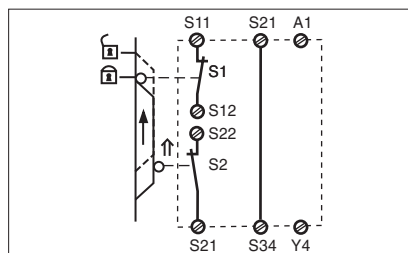

Category 4, EN 954-1 PNOZ e1p

General details

Unless stated otherwise in the technical details for the specific unit

Electrical data

AC frequency range	50 ... 60 Hz
DC residual ripple	160 %
Contact material	AgSnO ₂
Continuous duty	100 %

Environmental data

EMC	EN 50081-1, 01/92, EN 61000-6-2, 04/99	
Vibration in accordance with EN 60068-2-6, 04/95	Frequency: 10 ... 55 Hz, Amplitude: 0.35 mm	
Climatic suitability	DIN IEC 60068-2-3, 12/86	
Airgap creepage	DIN VDE 01101 Part 1, 04/97	
Ambient temperature	-10 ... +55 °C	
Storage temperature	-40 ... +85 °C	

Mechanical data

Torque setting for connection terminals	0.6 Nm (screws)
Mounting position	Any
Housing material	Thermoplastic Noryl SE 100
Protection types	Mounting: IP 54 Housing: IP 40 Terminals: IP 20

The units were tested in accordance with the standards applicable at the time of development.

Order reference

Type	U _B	Order number
PNOZ e1p	24 VDC	774 130

Order references accessories

Description	Order number
PLC Drivers for PNOZelog	874 130... ¹⁾

¹⁾ **When ordering, please state the type of licence you require after the order number** (..B for basic licence, ..K for copy licence, ..G for general licence, ..U for update licence), e.g. 301 400B.